



PRICING GUIDE

1015 Brundidge Blvd. | Troy, AL 36081
Phone: 1-800-264-4HBG | Fax: 1-334-566-4629
www.hbgcolumns.com

EFFECTIVE JANUARY 1, 2025

Not responsible for typographical errors

2025-V1 © 2025 HB&G Building Products, Inc.

PRICING GUIDE CONTENTS

PERMACAST® PLUS COLUMNS

Round Tapered PermaCast® Plus	2
Custom Fluting	4
Round No-Taper PermaCast® Plus	5
Round PermaCast® Split Plus Tapered	6
Round PermaCast® No-Taper Split Plus	8
Round Decorative Capitals for PermaCast® Plus	9
Round PermaCast® Plus Accesories	10
PermaLoc®	10
Round Caps and Bases for PermaCast® Plus	11
Round Tapered Parallel PermaCast® Plus Dimensions	12
Square PermaCast® Plus	13
Craftsman Style PermaCast® Plus	14
Square Recessed Panel PermaCast® Plus	14
Square PermaCast® Plus Split Column	15
Craftsman PermaCast® Plus Split Column	16
RoughSawn® PermaCast® Plus	16
Square PermaCast® Plus Accesories	17
Square Decorative Capitals and Square Caps and Bases for PermaCast® Plus	18

PERMAWRAP® COLUMN WRAP (2 L-shaped Halves)

PermaWrap® Plain and Woodgrain Non-Tapered	19
Raised Panel Non-Tapered PermaWrap®	20
Recessed Panel Non-Tapered PermaWrap®	20
Craftsman Tapered PermaWrap®	21
Pedestal PermaWrap®	22
Fluted Non-Tapered PermaWrap®	22
PermaSnap™	23
Caps and Bases for PermaWrap® Columns	24
Square PermaWrap® Custom Quote Form	25
Craftsman PermaWrap® Custom Quote Form	27

PERMALITE® COLUMNS

Square PermaLite®	29
Caps and Bases for PermaLite® Columns	30
SmartColumn®	31

WOOD COLUMNS

Wood Column Ordering Information	32
Custom Wood Quote Form	33
Round Tapered Wood Columns	34
Decorative Capitals for Wood Columns	35
Caps and Bases for Wood Columns	36

PERMAPOST®, CEILING, AND WOOD PORCH POSTS

PermaPost® - Colonial, Square, and Chamfered	37
Porch-Loc®	37
PermaPost® Lamp Post	38
Wood Turned Posts	39

PERMARAIL PLUS®

PermaRail Plus® - How To Order	40
PermaRail Plus®	41
Pre-Built PermaRail Plus®	43

BALUSTRADE SYSTEMS

6" Balustrade System	46
7" Balustrade System	47
12" Balustrade System	48
Curved Balustrade Systems	49

OUTDOOR LIVING

Mor-Shade®, Privacy Screens, Entry Arbors, Trellises, and Semi-Custom Options	50
Serenity® Fiberglass Pergola Series	51
Tranquility® Attached Fiberglass Pergola Series	51
Tranquility® Freestanding Fiberglass Pergola Series	52
Understanding Pergola Dimensions	52
Solace™ Fiberglass Pergola Series	53
<hr/>	
Point of Purchase Displays	54
Point of Purchase Samples	55
Point of Purchase Literature	56
Terms and Conditions	57



Phone: (800) 264-4HBG
Fax: (334) 566-4629
www.hbgcolumns.com

Round Tapered PermaCast® Plus Column List Pricing

Bottom Diameter X Height	Plain Shaft		Fluted Shaft		Cap & Base with Installation Kit and Flashing		Complete Column Shaft and C/B Installation Kit and Flashing		Wt (lbs)	Per Pallet
	Price	Stock #	Price	Stock #	Price	Stock #	Plain	Fluted		
6"x4'	\$186.49	44014	\$298.14	44014AF	\$101.64	44091X	Call	Call	25	24
6"x6'	\$212.83	44020	\$341.49	44020AF	\$84.70	44091	\$297.53	\$426.19	28	24
6"x8'	\$245.50	44040	\$396.47	44040AF	\$84.70	44091	\$330.19	\$481.17	37	24
8"x5'	\$239.17	45020	\$381.67	45020AF	\$84.70	45081	\$323.87	\$466.36	45	25
8"x6'	\$260.25	45030	\$418.67	45030AF	\$84.70	45081	\$344.94	\$503.37	45	25
8"x8'	\$262.35	45050	\$396.47	45060	\$84.70	45081	\$347.05	\$481.17	65	25
8"x9'	\$293.96	45064	\$429.25	45065	\$84.70	45081	\$378.66	\$513.94	66	25
8"x10'	\$324.52	45070	\$460.97	45080	\$84.70	45081	\$409.22	\$545.66	73	25
10"x6'	\$321.36	45089	\$515.94	45089AF	\$121.76	45141	\$443.11	\$637.70	75	16
10"x8'	\$313.98	45090	\$475.77	45100	\$121.76	45141	\$435.74	\$597.52	80	16
10"x9'	\$358.24	45104	\$532.86	45105	\$121.76	45141	\$479.99	\$654.62	88	16
10"x10'	\$397.22	45110	\$589.95	45120	\$121.76	45141	\$518.98	\$711.71	99	16
10"x12'	\$500.47	45130	\$745.37	45140	\$121.76	45141	\$622.23	\$867.13	122	12
12"x6'	\$421.46	45149	\$676.65	45149AF	\$163.05	45261	\$584.51	\$839.70	100	9
12"x8'	\$473.09	45150	\$588.90	45160	\$163.05	45261	\$636.14	\$751.95	114	9
12"x9'	\$527.88	45164	\$642.82	45165	\$163.05	45261	\$690.93	\$805.87	120	9
12"x10'	\$586.88	45170	\$699.91	45180	\$163.05	45261	\$749.93	\$862.96	134	9
12"x12'	\$796.57	45190	\$926.17	45200	\$163.05	45261	\$959.62	\$1,089.22	162	6
12"x14'	\$1,286.52	45210	\$1,549.97	45220	\$163.05	45261	\$1,449.57	\$1,713.02	185	N/A
12"x16'	\$1,537.30	45230	\$1,907.33	45240	\$163.05	45261	\$1,700.35	\$2,070.38	201	N/A
12"x18'	\$2,113.04	45250	\$2,537.47	45260	\$163.05	45261	\$2,276.09	\$2,700.52	235	N/A
14"x8'	\$894.56	45270	\$1,170.40	45280	\$444.70	45401	\$1,339.26	\$1,615.10	119	6
14"x9'	\$939.86	45274	\$1,508.73	45274AF	\$444.70	45401	\$1,384.56	\$1,953.43	138	6
14"x10'	\$986.23	45290	\$1,225.38	45300	\$444.70	45401	\$1,430.93	\$1,670.08	149	6
14"x12'	\$1,177.99	45310	\$1,363.99	45320	\$444.70	45401	\$1,622.69	\$1,808.69	185	6
14"x14'	\$1,397.16	45330	\$2,289.52	45330AF	\$444.70	45401	\$1,841.86	\$2,734.22	222	6
14"x16'	\$1,736.44	45350	\$2,843.84	45350AF	\$444.70	45401	\$2,181.14	\$3,288.53	253	N/A
14"x18'	\$2,094.94	45370	\$3,397.08	45370AF	\$444.70	45401	\$2,539.64	\$3,841.77	285	N/A
16"x8'	\$1,128.47	45408	\$1,325.82	45409	\$566.46	45521	\$1,694.94	\$1,892.29	128	N/A
16"x10'	\$1,404.53	45410	\$1,744.51	45420	\$566.46	45521	\$1,971.00	\$2,310.97	190	N/A
16"x12'	\$1,617.38	45430	\$2,648.64	45430AF	\$566.46	45521	\$2,183.84	\$3,215.10	200	N/A
16"x14'	\$1,910.30	45450	\$3,129.62	45450AF	\$566.46	45521	\$2,476.76	\$3,696.09	225	N/A
16"x16'	\$2,312.10	45470	\$3,751.88	45470AF	\$566.46	45521	\$2,878.57	\$4,318.35	237	N/A
16"x18'	\$2,654.87	45490	\$4,305.12	45490AF	\$566.46	45521	\$3,221.34	\$4,871.59	290	N/A
16"x20'	\$2,993.39	45510	\$4,856.20	45510AF	\$566.46	45521	\$3,559.85	\$5,422.67	312	N/A

- AF is a custom fluted column. Fluted columns that do not have the AF identifier can be custom fluted for a 60% upcharge
- Other sizes may be available. Call for quote.

Round PermaCast® Plus Columns can be custom fluted. See page 4.



Phone: (800) 264-4HBG
 Fax: (334) 566-4629
 www.hbgcolumns.com

Features

- Limited Lifetime Warranty
- PermaCast® Plus columns are cast from fiber-reinforced polymers.
- Plumb-Fit®, PermaFlashing, and Installation Kit available with select Tuscan Cap and Base Sets.
- Weatherproof
- Insect proof
- Low maintenance
- Load bearing
- Will never rot like wood columns
- Has many interior uses

For individual cap and base pricing, refer to pages 9 and 11.

Round Tapered PermaCast® Plus Column List Pricing

Bottom Diameter X Height	Plain Shaft		Fluted Shaft		Cap & Base with Installation Kit and Flashing		Complete Column Shaft and C/B Installation Kit and Flashing		Wt (lbs)	Per Pallet
	Price	Stock #	Price	Stock #	Price	Stock #	Plain	Fluted		
18"x8'	\$2,129.01	45690	\$3,453.15	45690AF	\$1,244.12	45581X	\$3,373.13	\$4,697.27	172	N/A
18"x10'	\$2,273.78	45700	\$3,686.10	45700AF	\$1,037.64	45581	\$3,311.42	\$4,723.74	204	N/A
18"x12'	\$2,426.00	45710	\$3,934.14	45710AF	\$1,037.64	45581	\$3,463.65	\$4,971.78	245	N/A
18"x14'	\$2,527.13	45720	\$4,095.90	45720AF	\$1,037.64	45581	\$3,564.78	\$5,133.55	286	N/A
18"x16'	\$2,660.19	45530	\$4,313.75	45530AF	\$1,037.64	45581	\$3,697.84	\$5,351.39	335	N/A
18"x18'	\$2,932.71	45540	\$4,754.83	45540AF	\$1,037.64	45581	\$3,970.35	\$5,792.48	370	N/A
18"x20'	\$3,421.32	45550	\$5,544.25	45550AF	\$1,037.64	45581	\$4,458.96	\$6,581.89	418	N/A
18"x22'	\$3,706.61	45560	\$6,007.98	45560AF	\$1,037.64	45581	\$4,744.25	\$7,045.62	435	N/A
18"x24'	\$4,007.86	45570	\$6,497.59	45570AF	\$1,037.64	45581	\$5,045.51	\$7,535.23	467	N/A
18"x26'	\$4,449.63	45580	\$7,212.60	45580AF	\$1,037.64	45581	\$5,487.28	\$8,250.24	484	N/A
20"x10'	\$2,940.16	45719	\$4,759.14	45719AF	\$1,381.77	45716X	\$4,321.93	\$6,140.91	309	N/A
20"x12'	\$3,089.19	45721	\$5,006.11	45721AF	\$1,381.77	45716X	\$4,470.96	\$6,387.87	359	N/A
20"x14'	\$3,257.38	45727	\$5,281.11	45727AF	\$1,381.77	45716X	\$4,639.15	\$6,662.88	409	N/A
20"x16'	\$3,372.35	45722	\$5,467.68	45722AF	\$1,150.94	45716	\$4,523.29	\$6,618.62	434	N/A
20"x18'	\$3,464.96	45723	\$5,616.50	45723AF	\$1,150.94	45716	\$4,615.90	\$6,767.44	459	N/A
20"x20'	\$3,632.09	45724	\$5,886.11	45724AF	\$1,150.94	45716	\$4,783.03	\$7,037.05	509	N/A
20"x22'	\$3,798.15	45725	\$6,156.80	45725AF	\$1,150.94	45716	\$4,949.09	\$7,307.74	559	N/A
20"x24'	\$4,078.12	45726	\$6,609.75	45726AF	\$1,150.94	45716	\$5,229.06	\$7,760.69	609	N/A
22"x16'	\$3,577.80	45730	\$5,798.76	45730AF	\$1,922.83	45731	\$5,500.63	\$7,721.59	475	N/A
22"x18'	\$3,984.44	45740	\$6,460.92	45740AF	\$1,922.83	45731	\$5,907.27	\$8,383.75	535	N/A
22"x20'	\$4,302.73	45750	\$6,975.34	45750AF	\$1,922.83	45731	\$6,225.56	\$8,898.17	594	N/A
22"x22'	\$4,624.21	45760	\$7,495.15	45760AF	\$1,922.83	45731	\$6,547.04	\$9,417.98	685	N/A
22"x24'	\$5,048.95	45770	\$8,185.35	45770AF	\$1,922.83	45731	\$6,971.78	\$10,108.18	747	N/A
22"x26'	\$5,503.50	45780	\$8,920.84	45780AF	\$1,922.83	45731	\$7,426.32	\$10,843.67	809	N/A
24"x12'	\$3,156.26	45800	\$5,115.03	45800AF	\$2,714.53	45900	\$5,870.79	\$7,829.56	508	N/A
24"x14'	\$3,253.13	45810	\$5,273.56	45810AF	\$2,714.53	45900	\$5,967.66	\$7,988.09	588	N/A
24"x16'	\$3,902.48	45820	\$6,325.04	45820AF	\$2,714.53	45900	\$6,617.01	\$9,039.57	671	N/A
24"x18'	\$4,523.08	45830	\$7,333.38	45830AF	\$2,714.53	45900	\$7,237.62	\$10,047.92	755	N/A
24"x20'	\$5,318.27	45840	\$8,619.96	45840AF	\$2,714.53	45900	\$8,032.81	\$11,334.49	839	N/A
24"x22'	\$5,951.65	45850	\$9,646.64	45850AF	\$2,714.53	45900	\$8,666.19	\$12,361.17	922	N/A
24"x24'	\$6,586.10	45860	\$10,676.55	45860AF	\$2,714.53	45900	\$9,300.63	\$13,391.08	1007	N/A
24"x26'	\$7,378.09	45870	\$11,963.12	45870AF	\$2,714.53	45900	\$10,092.63	\$14,677.66	1140	N/A
24"x28'	\$8,014.67	45880	\$12,991.96	45880AF	\$2,714.53	45900	\$10,729.20	\$15,706.49	1228	N/A
24"x30'	\$8,648.05	45890	\$14,016.47	45890AF	\$2,714.53	45900	\$11,362.59	\$16,731.01	1316	N/A

• AF is a custom fluted column. Fluted columns that do not have the AF identifier can be custom fluted for a 60% upcharge

What You Need To Know

- A complete column consists of shaft, cap, and base.
- Columns cannot be installed below grade or filled with concrete. Warranty will be void.
- Cap and base slides over shaft. The shaft rests on the floor.
- PermaCast® Plus columns used outside should not be painted using dark colors.
- Split columns are not load bearing.
- Pre-drill column prior to installing screws.
- Automotive body filler works great for minor repairs.
- When ordering a cap and base set, the Tuscan model is shipped unless otherwise specified.
- Columns need to be concentrically loaded below the header.

For individual cap and base pricing, refer to pages 9 and 11.

All Round PermaCast® Plus Columns can now be custom fluted. See page 4.



Phone: (800) 264-4HBG
Fax: (334) 566-4629
www.hbgcolumns.com

Round Tapered PermaCast® Plus Column List Pricing

Bottom Diameter X Height	Plain Shaft		Fluted Shaft		Cap & Base with Installation Kit and Flashing		Complete Column Shaft and C/B Installation Kit and Flashing		Wt (lbs)	Per Pallet
	Price	Stock #	Price	Stock #	Price	Stock #	Plain	Fluted		
28"x20'	\$7,493.06	45932	\$12,145.38	45932AF	\$3,223.44	45908	\$10,716.51	\$15,368.82	1450	N/A
28"x22'	\$7,876.28	45933	\$12,766.56	45933AF	\$3,223.44	45908	\$11,099.73	\$15,990.01	1600	N/A
28"x24'	\$8,213.73	45934	\$13,313.33	45934AF	\$3,223.44	45908	\$11,437.18	\$16,536.78	1750	N/A
28"x26'	\$8,786.44	45935	\$14,244.02	45935AF	\$3,223.44	45908	\$12,009.88	\$17,467.47	1950	N/A
28"x28'	\$9,510.30	45936	\$15,415.21	45936AF	\$3,223.44	45908	\$12,733.75	\$18,638.66	2100	N/A
30"x20'	\$7,697.45	45956	\$12,476.46	45956AF	\$4,686.38	45970	\$12,383.83	\$17,162.84	1700	N/A
30"x22'	\$8,724.70	45958	\$14,142.65	45958AF	\$4,686.38	45970	\$13,411.08	\$18,829.03	1900	N/A
30"x24'	\$9,753.01	45960	\$15,808.84	45960AF	\$4,686.38	45970	\$14,439.39	\$20,495.22	2100	N/A
30"x26'	\$10,779.20	45962	\$17,472.87	45962AF	\$4,686.38	45970	\$15,465.58	\$22,159.25	2300	N/A
30"x28'	\$11,804.32	45964	\$19,135.83	45964AF	\$4,686.38	45970	\$16,490.70	\$23,822.21	2500	N/A
30"x30'	\$12,831.57	45966	\$20,799.86	45966AF	\$4,686.38	45970	\$17,517.95	\$25,486.24	2700	N/A

- AF is a custom fluted column. Fluted columns that do not have the AF identifier can be custom fluted for a 60% upcharge.
- Go up a size if using split column

One Piece Neck Mould for No Taper Columns

Column Size	Price	SKU
8"	\$123.69	F50008PGN
10"	\$149.07	F50010PGN
12"	\$173.38	F50012PGN
14"	\$196.64	F50014PGN
16"	\$259.02	F50016PGN
18"	\$320.35	F50018PGN
24"	\$358.41	F50024PGN

- If ordering a split NT, go up a size in neck mould

FLUTED ROUND PERMACAST® PLUS COLUMN

All Round HB&G PermaCast® columns are available fluted!



Architectural Flute: Available in diameters of 8"x8'-16"x10'. See pages 2-4 for specific lengths available and price. The architectural flute is part of the manufacturing process and cannot be altered.



Custom Flute: The custom flute is milled after the column is manufactured and can be modified to your specific length. Please note flute length and placement.



Phone: (800) 264-4HBG
Fax: (334) 566-4629
www.hbgcolumns.com

No-Taper Round PermaCast® Plus Column List Pricing

Bottom Diameter X Height	Plain Shaft Price	Stock #	Tuscan Cap and Price	Base Set Stock #	Total Shaft Cap and Base Plain	Wt (lbs)	Per Pallet
8"x6'	\$292.91	49024	\$148.23	52013	\$441.14	52	25
8"x8'	\$319.25	49025	\$148.23	52013	\$467.48	52	25
8"x9'	\$394.06	49029	\$148.23	52013	\$542.29	52	25
8"x10'	\$397.22	49090	\$148.23	52013	\$545.45	62	20
10"x6'	\$337.16	49044	\$217.05	52016	\$554.21	63	16
10"x8'	\$404.60	49045	\$217.05	52016	\$621.65	63	16
10"x9'	\$448.85	49049	\$217.05	52016	\$665.90	63	16
10"x10'	\$535.25	49100	\$217.05	52016	\$752.30	90	16
10"x12'	\$698.57	49125	\$217.05	52016	\$915.62	122	12
12"x6'	\$425.67	49064	\$276.34	52019	\$702.02	93	9
12"x8'	\$500.48	49065	\$276.34	52019	\$776.83	93	9
12"x9'	\$564.76	49069	\$276.34	52019	\$841.10	93	9
12"x10'	\$640.62	49110	\$276.34	52019	\$916.97	104	9
12"x12'	\$799.73	49135	\$276.34	52019	\$1,076.07	132	6
14"x6'	\$649.05	49079	\$575.99	52023	\$1,225.05	102	6
14"x8'	\$916.68	49080	\$575.99	52023	\$1,492.68	102	6
14"x9'	\$964.10	49081	\$575.99	52023	\$1,540.09	102	6
14"x10'	\$1,021.00	49120	\$575.99	52023	\$1,596.99	128	6
14"x12'	\$1,224.36	49145	\$575.99	52023	\$1,800.35	152	5
14"x14'	\$1,411.91	49180	\$575.99	52023	\$1,987.90	190	N/A
16"x6'	\$841.87	49194	\$763.41	52026	\$1,605.28	102	6
16"x8'	\$1,133.74	49195	\$763.41	52026	\$1,897.15	102	6
16"x9'	\$1,182.21	49199	\$763.41	52026	\$1,945.62	102	6
16"x10'	\$1,467.75	49200	\$763.41	52026	\$2,231.16	204	N/A
16"x12'	\$1,701.67	49205	\$763.41	52026	\$2,465.08	245	N/A
16"x14'	\$2,241.84	49210	\$763.41	52026	\$3,005.25	286	N/A
16"x16'	\$2,459.00	49215	\$763.41	52026	\$3,222.41	335	N/A
16"x18'	\$2,742.16	49220	\$763.41	52026	\$3,505.57	370	N/A
16"x20'	\$3,091.32	49225	\$763.41	52026	\$3,854.73	418	N/A
18"x6'	\$1,957.62	49226	\$1,086.35	52029	\$3,043.97	204	N/A
18"x8'	\$2,132.20	49227	\$1,086.35	52029	\$3,218.55	204	N/A
18"x9'	\$2,207.78	49234	\$1,086.35	52029	\$3,294.13	204	N/A
18"x10'	\$2,448.36	49228	\$1,086.35	52029	\$3,534.71	204	N/A
18"x12'	\$2,655.94	49229	\$1,086.35	52029	\$3,742.29	245	N/A
18"x14'	\$2,699.58	49230	\$1,086.35	52029	\$3,785.93	286	N/A
18"x16'	\$2,879.48	49231	\$1,086.35	52029	\$3,965.83	335	N/A
18"x18'	\$3,173.29	49232	\$1,086.35	52029	\$4,259.64	370	N/A
18"x20'	\$3,632.09	49233	\$1,086.35	52029	\$4,718.44	418	N/A
24"x8'	\$2,459.00	49236	\$2,118.50	52038	\$4,577.51	420	N/A
24"x9'	\$2,735.77	49238	\$2,118.50	52038	\$4,854.28	430	N/A
24"x10'	\$2,865.64	49237	\$2,118.50	52038	\$4,984.15	450	N/A
24"x12'	\$3,421.32	49242	\$2,118.50	52038	\$5,539.82	493	N/A
24"x14'	\$3,990.83	49244	\$2,118.50	52038	\$6,109.33	549	N/A
24"x16'	\$4,561.41	49246	\$2,118.50	52038	\$6,679.91	567	N/A
24"x18'	\$5,113.89	49240	\$2,118.50	52038	\$7,232.39	739	N/A
24"x20'	\$5,666.37	49250	\$2,118.50	52038	\$7,784.87	821	N/A
24"x22'	\$6,234.81	49255	\$2,118.50	52038	\$8,353.32	NA	N/A
24"x24'	\$6,857.55	49260	\$2,118.50	52038	\$8,976.05	NA	N/A
24"x26'	\$7,545.22	49265	\$2,118.50	52038	\$9,663.72	NA	N/A
24"x28'	\$8,299.96	49270	\$2,118.50	52038	\$10,418.46	NA	N/A
24"x30'	\$9,131.34	49272	\$2,118.50	52038	\$11,249.84	NA	N/A

- Neck mould not included
- Plumb-Fit®, PermaFlashing, and Installation Kits are not available with no-taper cap and base sets.
- All No-Taper Columns can be custom fluted - 60% upcharge

• AF is a custom fluted column. Fluted columns that do not have the AF identifier can be custom fluted for a 60% upcharge.



Round Tapered PermaCast® Plus Split Column List Pricing

Bottom Diameter X Height	Split Shaft Plain (Does not include split kit)		Optional Adhesive Split Kit		Optional Flange Split Kit		Split Shaft Fluted (Does not include split kit)		Split w/Flashing and Installation Kit Cap and Base Set	
	Price	Stock #	Price	Stock #	Price	Stock #	Price	Stock #	Price	Stock #
6"x4'	\$231.80	44014S	\$102.55	17111	N/A	N/A	\$373.21	44014AFS	\$101.64	44091X
6"x6'	\$280.27	44020S	\$102.55	17111	N/A	N/A	\$450.39	44020AFS	\$100.58	44091S
6"x8'	\$337.16	44040S	\$102.55	17111	N/A	N/A	\$541.32	44040AFS	\$100.58	44091S
8"x5'	\$295.02	45020S	\$102.55	17111	\$136.38	17131	\$471.54	45020AFS	\$100.58	45081S
8"x6'	\$327.68	45030S	\$102.55	17111	\$136.38	17131	\$527.57	45030AFS	\$100.58	45081S
8"x8'	\$346.65	45050S	\$102.55	17111	\$136.38	17131	\$484.68	45060S	\$100.58	45081S
8"x9'	\$386.69	45064S	\$102.55	17111	\$136.38	17131	\$527.88	45065S	\$100.58	45081S
8"x10'	\$458.34	45070S	\$102.55	17111	\$136.38	17131	\$607.96	45080S	\$100.58	45081S
10"x6'	\$416.19	45089S	\$102.55	17111	\$145.89	17133	\$669.25	45089AFS	\$145.05	45141S
10"x8'	\$430.94	45090S	\$102.55	17111	\$145.89	17133	\$601.64	45100S	\$145.05	45141S
10"x9'	\$487.84	45104S	\$102.55	17111	\$145.89	17133	\$672.23	45105S	\$145.05	45141S
10"x10'	\$543.68	45110S	\$102.55	17111	\$145.89	17133	\$745.99	45120S	\$145.05	45141S
10"x12'	\$796.57	45130S	\$152.24	17112	\$145.89	17133	\$934.60	45140S	\$145.05	45141S
12"x6'	\$517.34	45149S	\$152.24	17112	\$145.89	17133	\$829.96	45149AFS	\$192.70	45261S
12"x8'	\$599.53	45150S	\$152.24	17112	\$145.89	17133	\$712.27	45160S	\$192.70	45261S
12"x9'	\$671.18	45164S	\$152.24	17112	\$145.89	17133	\$781.81	45165S	\$192.70	45261S
12"x10'	\$754.42	45170S	\$152.24	17112	\$145.89	17133	\$867.16	45180S	\$192.70	45261S
12"x12'	\$1,000.98	45190S	\$152.24	17112	\$145.89	17133	\$1,125.31	45200S	\$192.70	45261S
12"x14'	\$1,322.35	45210S	\$152.24	17112	N/A	N/A	\$1,476.18	45220S	\$192.70	45261S
12"x16'	\$1,783.86	45230S	\$152.24	17112	N/A	N/A	\$2,145.27	45240S	\$192.70	45261S
12"x18'	\$2,498.25	45250S	\$152.24	17112	N/A	N/A	\$2,934.47	45260S	\$192.70	45261S
14"x8'	\$995.71	45270S	\$152.24	17112	\$145.89	17133	\$1,267.56	45280S	\$526.23	45401S
14"x9'	\$1,054.72	45274S	\$152.24	17112	\$145.89	17133	\$1,692.70	45274AFS	\$526.23	45401S
14"x10'	\$1,121.10	45290S	\$152.24	17112	\$145.89	17133	\$1,351.85	45300S	\$526.23	45401S
14"x12'	\$1,339.21	45310S	\$152.24	17112	\$145.89	17133	\$1,616.32	45320S	\$526.23	45401S
14"x14'	\$1,596.75	45330S	\$152.24	17112	N/A	N/A	\$2,587.17	45330AFS	\$526.23	45401S
14"x16'	\$1,976.78	45350S	\$152.24	17112	N/A	N/A	\$2,707.69	45350AFS	\$526.23	45401S
14"x18'	\$2,465.39	45370S	\$152.24	17112	N/A	N/A	\$3,993.45	45370AFS	\$526.23	45401S
16"x8'	\$1,229.62	45408S	\$152.24	17112	\$145.89	17133	\$1,410.86	45409S	\$668.11	45521S
16"x10'	\$1,538.35	45410S	\$152.24	17112	\$145.89	17133	\$1,866.04	45420S	\$668.11	45521S
16"x12'	\$1,779.64	45430S	\$152.24	17112	N/A	N/A	\$2,915.01	45430AFS	\$668.11	45521S
16"x14'	\$2,125.81	45450S	\$152.24	17112	N/A	N/A	\$3,566.17	45450AFS	\$668.11	45521S
16"x16'	\$2,573.97	45470S	\$152.24	17112	N/A	N/A	\$4,172.47	45470AFS	\$668.11	45521S
16"x18'	\$3,022.13	45490S	\$152.24	17112	N/A	N/A	\$4,902.58	45490AFS	\$668.11	45521S
16"x20'	\$3,421.32	45510S	\$152.24	17112	N/A	N/A	\$5,547.48	45510AFS	\$668.11	45521S
18"x8'	\$2,215.23	45690S	\$201.93	17113	N/A	N/A	\$3,591.19	45690AFS	\$1,467.53	45581X
18"x10'	\$2,389.81	45700S	\$201.93	17113	N/A	N/A	\$3,871.59	45700AFS	\$1,222.94	45581S
18"x12'	\$2,567.58	45710S	\$201.93	17113	N/A	N/A	\$4,162.77	45710AFS	\$1,222.94	45581S
18"x14'	\$2,710.23	45720S	\$201.93	17113	N/A	N/A	\$4,395.71	45720AFS	\$1,222.94	45581S
18"x16'	\$2,921.00	45530S	\$201.93	17113	N/A	N/A	\$4,734.34	45530AFS	\$1,222.94	45581S
18"x18'	\$3,280.80	45540S	\$201.93	17113	N/A	N/A	\$5,318.86	45540AFS	\$1,222.94	45581S
18"x20'	\$3,821.57	45550S	\$201.93	17113	N/A	N/A	\$6,197.78	45550AFS	\$1,222.94	45581S
18"x22'	\$4,199.47	45560S	\$201.93	17113	N/A	N/A	\$6,809.26	45560AFS	\$1,222.94	45581S
18"x24'	\$4,602.92	45570S	\$201.93	17113	N/A	N/A	\$7,460.64	45570AFS	\$1,222.94	45581S
18"x26'	\$5,093.66	45580S	\$201.93	17113	N/A	N/A	\$8,258.68	45580AFS	\$1,222.94	45581S

• AF is a custom fluted column. Fluted columns that do not have the AF identifier can be custom fluted for a 60% upcharge.

* 30" split columns require 2 split kits

• Add additional 20% upcharge for custom splits.



Phone: (800) 264-4HBG
 Fax: (334) 566-4629
 www.hbgcolumns.com

17131 & 17133	17111, 17112, & 17113
Split Kit With Flange Includes 4 - 4 foot aluminum flange pieces Screws to install flange Adhesive* Installation instructions	Split Kit Includes 43" straps Adhesive* 4 - Aluminum Plates with screws Installation instructions

Round Tapered PermaCast® Plus Split Column List Pricing

Bottom Diameter X Height	Split Shaft Plain (Does not include split kit)		Optional Adhesive Split Kit		Optional Flange Split Kit		Split Shaft Fluted (Does not include split kit)		Split w/Flashing and Installation Kit Cap and Base Set	
	Price	Stock #	Price	Stock #	Price	Stock #	Price	Stock #	Price	Stock #
20"x10'	\$3,044.48	45719S	\$201.93	17113	N/A	N/A	\$4,934.93	45719AFS	\$1,381.77	45716X
20"x12'	\$3,220.13	45721S	\$201.93	17113	N/A	N/A	\$5,218.56	45721AFS	\$1,381.77	45716X
20"x14'	\$3,431.96	45727S	\$201.93	17113	N/A	N/A	\$5,561.50	45727AFS	\$1,381.77	45716X
20"x16'	\$3,643.80	45722S	\$201.93	17113	N/A	N/A	\$5,907.68	45722AFS	\$1,357.41	45716S
20"x18'	\$3,793.90	45723S	\$201.93	17113	N/A	N/A	\$6,149.25	45723AFS	\$1,357.41	45716S
20"x20'	\$4,011.06	45724S	\$201.93	17113	N/A	N/A	\$6,502.98	45724AFS	\$1,357.41	45716S
20"x22'	\$4,264.41	45725S	\$201.93	17113	N/A	N/A	\$6,910.63	45725AFS	\$1,357.41	45716S
20"x24'	\$4,639.12	45726S	\$201.93	17113	N/A	N/A	\$7,517.79	45726AFS	\$1,357.41	45716S
22"x16'	\$3,821.57	45730S	\$201.93	17113	N/A	N/A	\$6,196.71	45730AFS	\$2,265.89	45731S
22"x18'	\$4,313.38	45740S	\$201.93	17113	N/A	N/A	\$6,991.52	45740AFS	\$2,265.89	45731S
22"x20'	\$4,682.76	45750S	\$201.93	17113	N/A	N/A	\$7,591.13	45750AFS	\$2,265.89	45731S
22"x22'	\$5,089.40	45760S	\$201.93	17113	N/A	N/A	\$8,248.98	45760AFS	\$2,265.89	45731S
22"x24'	\$5,609.95	45770S	\$201.93	17113	N/A	N/A	\$9,094.47	45770AFS	\$2,265.89	45731S
22"x26'	\$6,109.20	45780S	\$201.93	17113	N/A	N/A	\$9,902.23	45780AFS	\$2,265.89	45731S
24"x12'	\$3,288.25	45800S	\$201.93	17113	N/A	N/A	\$5,328.56	45800AFS	\$3,197.95	45900S
24"x14'	\$3,425.58	45810S	\$201.93	17113	N/A	N/A	\$5,552.88	45810AFS	\$3,197.95	45900S
24"x16'	\$4,149.44	45820S	\$201.93	17113	N/A	N/A	\$6,724.06	45820AFS	\$3,197.95	45900S
24"x18'	\$4,850.95	45830S	\$201.93	17113	N/A	N/A	\$7,863.97	45830AFS	\$3,197.95	45900S
24"x20'	\$5,696.17	45840S	\$201.93	17113	N/A	N/A	\$9,234.67	45840AFS	\$3,197.95	45900S
24"x22'	\$6,417.91	45850S	\$201.93	17113	N/A	N/A	\$10,401.54	45850AFS	\$3,197.95	45900S
24"x24'	\$7,147.10	45860S	\$201.93	17113	N/A	N/A	\$11,584.59	45860AFS	\$3,197.95	45900S
24"x26'	\$7,985.93	45870S	\$201.93	17113	N/A	N/A	\$12,944.50	45870AFS	\$3,197.95	45900S
24"x28'	\$8,833.28	45880S	\$201.93	17113	N/A	N/A	\$14,315.20	45880AFS	\$3,197.95	45900S
24"x30'	\$9,524.14	45890S	\$201.93	17113	N/A	N/A	\$15,436.78	45890AFS	\$3,197.95	45900S
28"x20'	\$7,874.16	45932S	\$201.93	17113	N/A	N/A	\$12,763.33	45932AFS	\$3,798.23	45908S
28"x22'	\$8,340.41	45933S	\$201.93	17113	N/A	N/A	\$13,520.39	45933AFS	\$3,798.23	45908S
28"x24'	\$8,771.54	45934S	\$201.93	17113	N/A	N/A	\$14,220.30	45934AFS	\$3,798.23	45908S
28"x26'	\$9,396.40	45935S	\$201.93	17113	N/A	N/A	\$15,229.72	45935AFS	\$3,798.23	45908S
28"x28'	\$10,327.85	45936S	\$201.93	17113	N/A	N/A	\$16,740.61	45936AFS	\$3,798.23	45908S
30"x20'	\$8,052.99	45956S	\$201.93	17113*	N/A	N/A	\$13,054.51	45956AFS	\$5,544.88	45970S
30"x22'	\$9,162.21	45958S	\$201.93	17113*	N/A	N/A	\$14,850.11	45958AFS	\$5,544.88	45970S
30"x24'	\$10,278.88	45960S	\$201.93	17113*	N/A	N/A	\$16,659.73	45960AFS	\$5,544.88	45970S
30"x26'	\$11,349.77	45962S	\$201.93	17113*	N/A	N/A	\$18,396.02	45962AFS	\$5,544.88	45970S
30"x28'	\$12,571.83	45964S	\$201.93	17113*	N/A	N/A	\$20,380.35	45964AFS	\$5,544.88	45970S
30"x30'	\$13,654.43	45966S	\$201.93	17113*	N/A	N/A	\$22,131.73	45966AFS	\$5,544.88	45970S

* 30" split columns require 2 split kits.

- AF is a custom fluted column. Fluted columns that do not have the AF identifier can be custom fluted for a 60% upcharge.
- Add additional 20% upcharge for custom splits.

17131 & 17133	17111, 17112, & 17113
Split Kit With Flange Includes 4 - 4 foot aluminum flange pieces Screws to install flange Adhesive* Installation instructions	Split Kit Includes 43" straps Adhesive* 4 - Aluminum Plates with screws Installation instructions



Phone: (800) 264-4HBG
 Fax: (334) 566-4629
 www.hbgcolumns.com

Round PermaCast® Plus No-Taper Split Column List Pricing

Bottom Diameter X Height	Split Shaft Plain (Does not include split kit)		Optional Adhesive Split Kit		Optional Flange Split Kit		Split Cap and Base Set	
	Price	Stock #	Price	Stock #	Price	Stock #	Price	Stock #
8"x6'	\$359.29	49024S	\$102.55	17111	\$133.12	17131	\$179.99	52013S
8"x8'	\$410.92	49025S	\$102.55	17111	\$133.12	17131	\$179.99	52013S
8"x9'	\$505.75	49029S	\$102.55	17111	\$133.12	17131	\$179.99	52013S
8"x10'	\$543.68	49090S	\$102.55	17111	\$133.12	17131	\$179.99	52013S
10"x6'	\$446.75	49044S	\$102.55	17111	\$142.41	17133	\$260.46	52016S
10"x8'	\$508.91	49045S	\$102.55	17111	\$142.41	17133	\$260.46	52016S
10"x9'	\$594.26	49049S	\$102.55	17111	\$142.41	17133	\$260.46	52016S
10"x10'	\$693.31	49100S	\$102.55	17111	\$142.41	17133	\$260.46	52016S
10"x12'	\$887.18	49125S	\$102.55	17111	\$142.41	17133	\$260.46	52016S
12"x6'	\$521.56	49064S	\$152.24	17112	\$142.41	17133	\$332.46	52019S
12"x8'	\$614.28	49065S	\$152.24	17112	\$142.41	17133	\$332.46	52019S
12"x9'	\$694.36	49069S	\$152.24	17112	\$142.41	17133	\$332.46	52019S
12"x10'	\$794.46	49110S	\$152.24	17112	\$142.41	17133	\$332.46	52019S
12"x12'	\$1,022.05	49135S	\$152.24	17112	\$142.41	17133	\$332.46	52019S
14"x6'	\$779.71	49079S	\$152.24	17112	N/A	N/A	\$690.35	52023S
14"x8'	\$1,008.35	49080S	\$152.24	17112	N/A	N/A	\$690.35	52023S
14"x9'	\$1,067.36	49081S	\$152.24	17112	N/A	N/A	\$690.35	52023S
14"x10'	\$1,142.17	49120S	\$152.24	17112	N/A	N/A	\$690.35	52023S
14"x12'	\$1,370.82	49145S	\$152.24	17112	N/A	N/A	\$690.35	52023S
14"x14'	\$1,772.27	49180S	\$152.24	17112	N/A	N/A	\$690.35	52023S
16"x6'	\$909.31	49194S	\$152.24	17112	N/A	N/A	\$915.88	52026S
16"x8'	\$1,237.00	49195S	\$152.24	17112	N/A	N/A	\$915.88	52026S
16"x9'	\$1,362.39	49199S	\$152.24	17112	N/A	N/A	\$915.88	52026S
16"x10'	\$1,584.71	49200S	\$152.24	17112	N/A	N/A	\$915.88	52026S
16"x12'	\$1,847.08	49205S	\$152.24	17112	N/A	N/A	\$915.88	52026S
16"x14'	\$2,411.84	49210S	\$152.24	17112	N/A	N/A	\$915.88	52026S
16"x16'	\$2,646.81	49215S	\$152.24	17112	N/A	N/A	\$915.88	52026S
16"x18'	\$3,194.58	49220S	\$152.24	17112	N/A	N/A	\$915.88	52026S
16"x20'	\$3,596.96	49225S	\$152.24	17112	N/A	N/A	\$915.88	52026S
18"x6'	\$2,018.30	49226S	\$201.93	17113	N/A	N/A	\$1,304.47	52029S
18"x8'	\$2,219.49	49227S	\$201.93	17113	N/A	N/A	\$1,304.47	52029S
18"x9'	\$2,304.65	49234S	\$201.93	17113	N/A	N/A	\$1,304.47	52029S
18"x10'	\$2,566.52	49228S	\$201.93	17113	N/A	N/A	\$1,304.47	52029S
18"x12'	\$2,793.26	49229S	\$201.93	17113	N/A	N/A	\$1,304.47	52029S
18"x14'	\$2,872.03	49230S	\$201.93	17113	N/A	N/A	\$1,304.47	52029S
18"x16'	\$3,215.87	49231S	\$201.93	17113	N/A	N/A	\$1,304.47	52029S
18"x18'	\$3,586.32	49232S	\$201.93	17113	N/A	N/A	\$1,304.47	52029S
18"x20'	\$4,082.38	49233S	\$201.93	17113	N/A	N/A	\$1,304.47	52029S
24"x8'	\$2,545.23	49236S	\$201.93	17113	N/A	N/A	\$2,543.48	52038S
24"x10'	\$3,074.29	49237S	\$201.93	17113	N/A	N/A	\$2,543.48	52038S
24"x12'	\$3,185.00	49242S	\$201.93	17113	N/A	N/A	\$2,543.48	52038S
24"x14'	\$4,444.31	49244S	\$201.93	17113	N/A	N/A	\$2,543.48	52038S
24"x16'	\$5,110.69	49246S	\$201.93	17113	N/A	N/A	\$2,543.48	52038S
24"x18'	\$5,766.43	49240S	\$201.93	17113	N/A	N/A	\$2,543.48	52038S
24"x20'	\$6,425.36	49250S	\$201.93	17113	N/A	N/A	\$2,543.48	52038S
24"x22'	\$7,481.35	49255S	\$201.93	17113	N/A	N/A	\$2,543.48	52038S
24"x24'	\$8,229.70	49260S	\$201.93	17113	N/A	N/A	\$2,543.48	52038S
24"x26'	\$9,053.63	49265S	\$201.93	17113	N/A	N/A	\$2,543.48	52038S
24"x28'	\$9,960.59	49270S	\$201.93	17113	N/A	N/A	\$2,543.48	52038S
24"x30'	\$10,959.10	49272S	\$201.93	17113	N/A	N/A	\$2,543.48	52038S



Phone: (800) 264-4HBG
 Fax: (334) 566-4629
 www.hbgcolumns.com

17131 & 17133	17111, 17112, & 17113
Split Kit With Flange Includes 4 - 4 foot aluminum flange pieces Screws to install flange Adhesive* Installation instructions	Split Kit Includes 43" straps Adhesive* 4 - Aluminum Plates with screws Installation instructions

- Add additional 20% upcharge for custom splits.
- AF is a custom fluted column. See page 4. Fluted columns that do not have the AF can be custom fluted - 60% upcharge.
- Installation Kit with flashing not available with no taper cap and base set.
- Neck mould not included.

Decorative Capitals for Round Tapered PermaCast® Plus Columns List Pricing

Capital	6" Round		8" Round		10"* Round		12"* Round	
	Price	Stock #	Price	Stock #	Price	Stock #	Price	Stock #
Roman Ionic	N/A	N/A	\$281.88	76911	\$378.85	76912	\$563.54	76913
Greek Ionic	N/A	N/A	\$307.29	76901	\$410.51	76902	\$504.96	76903
Temple of the Winds	N/A	N/A	\$453.65	76941	\$718.20	76942	\$909.44	76943
Roman Corinthian	N/A	N/A	\$431.34	76921	\$903.07	76922	\$1,387.54	76923
Scamozzi	N/A	N/A	\$217.42	76931	\$392.85	76932	\$624.79	76933

Capital	14" Round		16" Round		18" Round		20" Round	
	Price	Stock #	Price	Stock #	Price	Stock #	Price	Stock #
Roman Ionic	\$872.18	77347	\$959.41	77261	\$1,319.61	77271	\$1,470.43	77265
Greek Ionic	\$945.10	77349	\$1,015.68	77161	\$1,407.38	77171	\$1,618.63	77173
Temple of the Winds	\$1,151.68	77541	\$2,253.43	77561	\$2,500.98	77571	\$2,524.36	77573
Roman Corinthian	\$2,431.93	77343	\$3,152.26	77361	\$4,073.40	77363	\$4,818.17	77365
Scamozzi	\$900.09	77345	\$1,303.08	77461	\$1,507.91	77471	\$1,854.69	77473

Price	22" Round		24" Round		30" Round	
	Price	Stock #	Price	Stock #	Price	Stock #
Roman Ionic	\$1,839.10	77267	\$2,173.05	77269	N/A	N/A
Greek Ionic	\$1,944.43	77175	\$2,351.43	77177	\$5,827.10	77183
Temple of the Winds	\$3,336.06	77575	\$3,373.25	77577	N/A	N/A
Roman Corinthian	\$6,672.14	77367	\$8,167.00	77369	N/A	N/A
Scamozzi	\$2,243.02	77475	\$2,616.37	77477	\$4,053.84	77483

*Load Bearing

- Split charge for ornamental capitals: add 20% to list price



Roman Ionic



Greek Ionic



Temple of the Winds



Roman Corinthian



Scamozzi

What You Need To Know

- 8" - 12" Decorative Capitals for round PermaCast® Plus are load bearing.
- Split Decorative Capitals are not load bearing.
- 14" - 30" Decorative Capitals are not load bearing and include a plug to transfer the load.
- Inside diameter of the Decorative Capital is smaller than the inside top diameter of the shaft.

Features

- Molded from polyurethane resin
- Weather, rot, and insect proof
- Lightweight for easy installation

Add 20% to all split Decorative Capitals.

Accessories for Round PermaCast® Plus Columns List Pricing

Perma-Loc®

The new uplift anchoring system from HB&G® is versatile, easy to install and affordable. The code compliant hardware kits provide the function needed to protect column supported projecting roof lines from wind uplift forces, while solving for common coastal challenges for residential, commercial and municipal installations.

Available SKUs			
SKU	Description	Qty.	List Price
17150	12' Perma-Loc		\$237.88
17150MP	12' Perma-Loc		
	Multi Pack 12 units		\$2,854.54
17151	16' Perma-Loc		\$259.02
17151MP	16' Perma-Loc		
	Multi Pack 12 units		\$3,108.29
17152	20' Perma-Loc		\$281.23
17152MP	20' Perma-Loc		
	Multi Pack 12 units		\$3,374.72

Perma-Loc® Features and Benefits:

- 4,200 lb strength galvanized aircraft cable combined with 316 stainless steel marine-grade attachment hardware for optimal uplift resistance. Exceeds the required capacity for 1,000 lb. uplift
- Perma-Loc® eliminates the need to split a column, along with all of the labor and material costs associated with splitting and re-joining two column halves.
- All hardware is included for concrete substrate applications.
- Available in three sizes: up to 12', 16', and 20' lengths.
- Extremely cost effective and versatile application that covers the entire spectrum of HB&G load bearing products.
- Patented design accompanied by certified/stamped engineering documentation.
- Florida Department of Business and Professional Regulation approval pending.



Split Column Assembly and Flange Kits

HB&G offers a split kit and a split kit with flange option with an improved adhesive.* This kit can be purchased separately. See pages 6, 7, 8, 15, and 16 for appropriate kit and list pricing. (Stock # 17111 shown.)

SPLIT KITS

List Price	Stock #
\$102.55	17111
\$152.24	17112
\$201.93	17113

SPLIT KIT W/FLANGE

List Price	Stock #
\$133.12	17131
\$142.41	17133

*Adhesive has specific storage and handling requirements.



Column Installation Kit

Price	Stock #
\$17.96	17040

Includes 4 brackets (2-top, 2-bottom) and all required hardware.

NOTE: Installation kits that are included with selected Tuscan Cap and Base Sets only have 2 brackets.



17040

Second Story Porch Bracket



Price	Stock #
\$971.63	17121

Includes 3 brackets and all required hardware. Fits 20" - 30" plain round PermaCast® Plus column. One kit required for each column.



Phone: (800) 264-4HBG
Fax: (334) 566-4629
www.hbgcolumns.com

Cap and Base Options for Round PermaCast® Plus Columns List Pricing

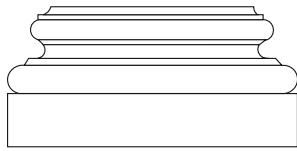

Attic Base

Attic Round Base for PermaCast® Plus

Column Size	Torus		Plinth		Set	
	Price	Stock #	Price	Stock #	Price	Stock #
6"	\$57.17	54081	\$37.05	13093	\$95.28	53000
8"	\$88.93	54091	\$63.52	14033	\$152.46	53010
10"	\$133.40	54111	\$110.11	14073	\$243.52	53020
12"	\$163.05	54131	\$133.40	14113	\$296.46	53030
14"	\$194.81	54151	\$245.64	14143	\$440.46	53040
16"	\$275.29	54171	\$287.99	14173	\$565.41	53050
18"	\$365.29	54191	\$528.35	14203	\$893.54	53060
20"	\$588.70	54201	\$803.64	14213	\$1,392.34	53065
22"	\$746.47	54210	\$835.41	14243	\$1,581.89	53070
24"	\$1,227.18	54220	\$2,288.13	14263	\$3,529.42	53080
28"	Call	Call	Call	Call	Call	Call
30"	\$1,523.64	54250	\$2,827.07	14323	\$4,366.63	53100

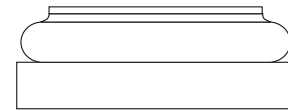

Tuscan Base

(Tuscan Style Caps and Bases Made of Polyurethane are Standard.)

Tuscan Round Caps & Bases for PermaCast® Plus

Column Size	Tapered Cap Price	Tapered Cap Stock #	No-Tapered Cap		Base	
			Price	Stock #	Price	Stock #
6"	\$32.81	44093	N/A	N/A	\$48.70	44092
8"	\$32.81	45083	\$97.40	52011	\$48.70	45082
10"	\$47.64	45143	\$147.17	52014	\$69.87	45142
12"	\$62.46	45263	\$182.10	52017	\$95.28	45262
14"	\$173.64	45403	\$319.75	52021	\$256.23	45402
16"	\$245.64	45523	\$461.64	52024	\$298.58	45522
18"	\$321.87	45583	\$651.16	52027	\$674.47	45582
20"	\$369.52	45718	N/A	N/A	\$738.00	45717
22"	\$529.41	45733	N/A	N/A	\$1,318.24	45732
24"	\$698.02	45903	\$818.06	52036	\$1,912.39	45902
28"	\$1,158.05	45909	N/A	N/A	\$1,941.07	45910
30"	\$1,581.97	45973	N/A	N/A	\$2,942.96	45972

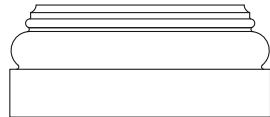

Doric Base

Doric Round Caps & Bases for PermaCast® Plus

Tapered Column Size	Cap Price	Cap Stock #	Base		Set	
			Price	Stock #	Price	Stock #
8"	\$53.99	54435	\$81.52	54436	\$135.51	54437
10"	\$78.34	54438	\$116.46	54439	\$194.80	54440
12"	\$105.87	54441	\$160.93	54442	\$266.80	54443
14"	\$206.46	54444	\$309.17	54445	\$515.63	54446
16"	\$380.11	54447	\$584.46	54448	\$964.57	54449
18"	\$570.70	54450	\$884.59	54451	\$1,455.29	54452

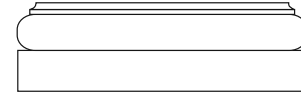

Colonial Bases

Low Profile for Use in Railing Applications

Colonial Round Caps & Bases for PermaCast® Plus

Tapered Column Size	Cap Price	Cap Stock #	Base		Set	
			Price	Stock #	Price	Stock #
6"	\$31.75	44094	\$35.99	44095	\$69.51	44096
8"	\$31.75	45086	\$39.17	45087	\$72.76	45088
10"	\$46.58	45146	\$52.93	45147	\$102.10	45148
12"	\$52.93	45266	\$64.58	45267	\$120.56	45268

Tuscan Round Cap & Base Sets For PermaCast® Plus

Tapered Column Size	Cap and Base Set		PermaTuff® Base with Poly Cap w/flashing kit and installation kit		PermaTuff® Base with Poly Cap w/ no flashing kit and installation kit	
	Price	Stock #	Price	Stock #	Price	Stock #
6"	\$81.52	40050	N/A	N/A	N/A	N/A
8"	\$83.64	40051	\$81.52	40200	\$78.34	40211
10"	\$118.58	40052	\$115.40	40202	\$112.23	40213
12"	\$157.76	40053	\$157.76	40204	\$149.28	40215
14"	\$428.82	7058141402	N/A	N/A	N/A	N/A
16"	\$544.23	7058161602	N/A	N/A	N/A	N/A
18"	\$996.35	7058181802	N/A	N/A	N/A	N/A
20"	\$1,107.53	7058202002	N/A	N/A	N/A	N/A
22"	\$1,848.71	7058222202	N/A	N/A	N/A	N/A
24"	\$2,599.42	7058242402	N/A	N/A	N/A	N/A
28"	\$3,087.54	7058282802	N/A	N/A	N/A	N/A
30"	\$4,507.44	45970	N/A	N/A	N/A	N/A

Round HD Poly Base with Poly Cap*

Column Size	Stock #	List Price
8"	\$91.05	40221
10"	\$186.34	40223
12"	\$231.87	40225

*No Flashing Cap or Installation Kit included

- Add an additional 20% upcharge for custom splits.
- Other sizes may be available. Call for quote.
- Cannot Split PermaTuff

**Split Charge
20%**



Phone: (800) 264-4HBG
Fax: (334) 566-4629
www.hbgcolumns.com

Entasis

Parallel Dimensions are used to specify where the column begins to taper. These dimensions use length from the bottom of the column shaft to the point where the taper begins. This is necessary to determine how much a column can be shortened before the base begins to fit loosely. Filler and caulking may be used to fill the gap between the base and shaft if it is necessary to shorten the column beyond the parallel dimension.

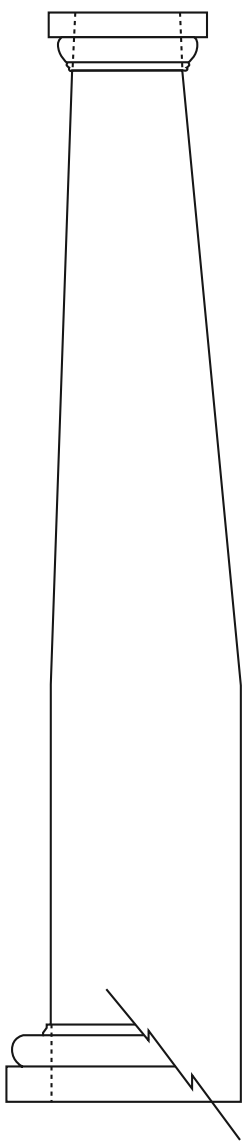

Round Tapered PermaCast® Plus Columns Parallel Dimensions

Column Size	Parallel Dimension	Column Size	Parallel Dimension	Column Size	Parallel Dimension	Column Size	Parallel Dimension
6x4*	0"	14x8	32"	20x10*	0"	28x20	20"
6x6	8"	14x9	12"	20x12*	0"	28x22	44"
6x8	32"	14x10	24"	20x14*	0"	28x24	68"
8x5	12"	14x12	48"	20x16	4"	28x26	92"
8x6	24"	14x14	27"	20x18	28"	28x28	116"
8x8	32"	14x16	51"	20x20	52"	30x20	92"
8x9	28"	14x18	75"	20x22	76"	30x22	116"
8x10	40"	16x8	16"	20x24	100"	30x24	140"
10x6	8"	16x10	40"	22x16	45"	30x26	75"
10x8	32"	16x12	29"	22x18	69"	30x28	99"
10x9	28"	16x14	53"	22x20	93"	30x30	123"
10x10	40"	16x16	36"	22x22	53"		
10x12	48"	16x18	60"	22x24	77"		
12x6	8"	16x20	84"	22x26	101"		
12x8	32"	18x8*	0"	24x12	21"		
12x9	20"	18x10	16"	24x14	45"		
12x10	32"	18x12	40"	24x16	69"		
12x12	48"	18x14	48"	24x18	93"		
12x14	59"	18x16	36"	24x20	75"		
12x16	40"	18x18	60"	24x22	99"		
12x18	73"	18x20	84"	24x24	123"		
		18x22	49"	24x26	77"		
		18x24	73"	24x28	101"		
		18x26	97"	24x30	125"		

Column* Size	Bottom Diameter
6x4	5 ³ / ₈ "
18x8	17 ¹ / ₄ "
20x10	18 ¹¹ / ₁₆ "
20x12	18 ⁵ / ₁₆ "
20x14	19 ¹ / ₄ "

Tips:

- ✓ When ordering a decorative capital, refer to page 9 and 11 (round) and page 18 (square) and order the appropriate base for the column.
- ✓ When ordering a decorative capital for round tapered columns, remove the "T" dimension and add height of decorative capital, this can lengthen or shorten the height of the column. You can find the "T" dimension in the products brochure.
- ✓ Decorative capitals for square PermaCast® Plus slide over the shaft and do not use a plug. These decorative capitals will not lengthen or shorten the height of the column.
- ✓ Ensure exact opening measurement prior to ordering column length.
- ✓ When installing a PermaCast® Plus column, ensure concentric loading of column, 100% of bottom must contact substrate, and 75% of top must contact soffit.
- ✓ When attaching hand rails and brackets to PermaCast® Plus columns, holes must be pre-drilled before applying screws.
- ✓ Use a screw with a wide thread pattern, i.e. deck screw, concrete screw, or hollow wall anchor.
- ✓ When ordering panel moulding for square PermaCast® Plus column, make sure to order enough for four sides of column.
- ✓ Plain Square PermaCast® Plus columns are not tapered and can be cut to any length.
- ✓ Do not paint PermaCast® Plus columns using dark colors.

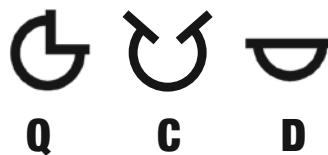

Round Column Splitting Options:

- Add additional 20% upcharge for custom splits (Q and C patterns).



Phone: (800) 264-4HBG
 Fax: (334) 566-4629
 www.hbgcolumns.com

Square PermaCast® Plus Column List Pricing

Bottom Width X Height	Plain Shaft		Fluted Shaft		Cap & Base Set with Installation Kit, Flashing, and Neck Mould		Complete Column Shaft & C/B with Installation Kit Neck and Flashing		Wt. (lbs)	Per Pallet
	Price	Stock #	Price	Stock #	Price	Stock #	Plain	Fluted		
6"x6'	\$348.75	45988	N/A	N/A	\$110.11	54297	\$458.86	N/A	46	24
6"x8'	\$399.33	45990	N/A	N/A	\$110.11	54297	\$509.44	N/A	61	24
6"x9'	\$424.62	45991	N/A	N/A	\$110.11	54297	\$534.73	N/A	70	24
6"x10'	\$446.75	45992	N/A	N/A	\$110.11	54297	\$556.85	N/A	77	24
8"x6'	\$429.89	46008	N/A	N/A	\$117.36	54301	\$547.25	N/A	59	20
8"x8'	\$508.91	46010	\$683.38	46210	\$117.36	54301	\$626.28	\$800.75	78	20
8"x9'	\$552.11	46011	\$809.08	46211	\$117.36	54301	\$669.48	\$926.44	89	20
8"x10'	\$596.37	46012	\$858.72	46212	\$117.36	54301	\$713.73	\$976.09	98	20
8"x12'	\$727.02	46014	N/A	N/A	\$117.36	54301	\$844.39	N/A	117	15
10"x51"	\$444.64	46026	N/A	N/A	\$169.28	54305	\$613.92	N/A	51	16
10"x6'	\$560.54	46028	N/A	N/A	\$169.28	54305	\$729.82	N/A	75	16
10"x8'	\$641.68	46030	N/A	N/A	\$169.28	54305	\$810.95	N/A	102	16
10"x9'	\$707.00	46031	N/A	N/A	\$169.28	54305	\$876.28	N/A	114	16
10"x10'	\$772.33	46032	\$1,134.40	46232	\$169.28	54305	\$941.61	\$1,303.68	132	16
10"x12'	\$916.68	46034	N/A	N/A	\$169.28	54305	\$1,085.96	N/A	147	12
10"x14'	\$1,488.83	46036	N/A	N/A	\$169.28	54305	\$1,658.11	N/A	168	N/A
10"x16'	\$1,850.24	46038	N/A	N/A	\$169.28	54305	\$2,019.52	N/A	203	N/A
12"x8'	\$799.73	46050	N/A	N/A	\$258.34	54309	\$1,058.07	N/A	120	9
12"x9'	\$884.02	46051	N/A	N/A	\$258.34	54309	\$1,142.36	N/A	140	9
12"x10'	\$968.31	46052	N/A	N/A	\$258.34	54309	\$1,226.66	N/A	160	9
12"x12'	\$1,121.10	46054	N/A	N/A	\$258.34	54309	\$1,379.44	N/A	197	6
12"x14'	\$1,909.24	46056	N/A	N/A	\$258.34	54309	\$2,167.59	N/A	225	N/A
12"x16'	\$2,069.39	46058	N/A	N/A	\$258.34	54309	\$2,327.74	N/A	257	N/A
12"x18'	\$2,502.65	46060	N/A	N/A	\$258.34	54309	\$2,760.99	N/A	289	N/A
14"x8'	\$1,578.39	46070	N/A	N/A	\$418.23	54313	\$1,996.62	N/A	185	N/A
14"x10'	\$1,931.37	46072	N/A	N/A	\$418.23	54313	\$2,349.60	N/A	210	N/A
14"x12'	\$2,441.97	46074	N/A	N/A	\$418.23	54313	\$2,860.20	N/A	235	N/A
14"x14'	\$2,742.16	46076	N/A	N/A	\$418.23	54313	\$3,160.39	N/A	250	N/A
16"x8'	\$2,032.14	46090	N/A	N/A	\$592.94	54317	\$2,625.07	N/A	242	N/A
16"x10'	\$2,249.29	46092	N/A	N/A	\$592.94	54317	\$2,842.23	N/A	301	N/A
16"x12'	\$2,534.58	46094	N/A	N/A	\$592.94	54317	\$3,127.52	N/A	362	N/A
16"x14'	\$2,742.16	46096	N/A	N/A	\$592.94	54317	\$3,335.10	N/A	422	N/A
16"x16'	\$3,031.71	46098	N/A	N/A	\$592.94	54317	\$3,624.64	N/A	482	N/A
16"x18'	\$3,330.83	46100	N/A	N/A	\$592.94	54317	\$3,923.77	N/A	542	N/A
16"x20'	\$3,621.45	46102	N/A	N/A	\$592.94	54317	\$4,214.38	N/A	602	N/A

Features

- Limited Lifetime Warranty
- PermaCast® Plus columns are cast from fiber-reinforced polymers
- Weatherproof
- Insect proof
- Low maintenance
- Load bearing
- Will never rot like wood columns
- Has many interior uses

What You Need To Know

- A complete column consists of shaft, neck moulding, cap and base.
- Cap and base slide over shaft. The shaft rests on floor, with 100% contact to substrate.
- Neck moulding is included with Tuscan cap and base set and can be applied.
- PermaCast® Plus columns used outside should not be painted using dark colors.
- Columns should not be installed below grade or filled with concrete or the warranty will be void.
- Split columns are not load bearing.
- Pre-drill column prior to installing screws.
- Automotive body filler works great for minor repairs.
- When ordering a cap and base set, the Tuscan model is shipped unless otherwise specified.
- Never shim a column to attain desired height.

For individual cap and base pricing, refer to page 18.

Craftsman Style PermaCast® Plus Column List Pricing

Bottom Width X Top Width X Height	Price	Shaft		Cap & Base Set		Complete Column Shaft & C/B Set Price	Wt. (lbs.)	Per Pallet
		Stock #		Price	Stock #			
10"x5.5"x66"	\$528.12	46358		\$148.23	46359	\$676.34	54	12
10.25"x7.5"x7'	\$785.84	70061007PL		\$184.23	7062101002	\$970.07	70	12
10"x8"x66"	\$617.90	C1071006AC		\$182.11	C5251000	\$800.01	70	8
12"x8"x5'	\$785.84	46332		\$235.05	46345	\$1,020.89	65	8
12"x8"x6'	\$869.28	46334		\$235.05	46345	\$1,104.33	70	8
12"x10"x6'	\$913.65	46336		\$266.82	46341	\$1,180.46	70	8
12"x10"x10'	\$1,099.55	46340		\$266.82	46341	\$1,366.37	110	6
14"x12"x9'	\$1,629.79	70061409PL		\$279.52	7062141402	\$1,909.31	212	6
16"x9"x58"	\$605.22	46350		\$321.87	46351	\$927.10	80	6
16"x9"x6'	\$928.43	46362		\$337.76	46355	\$1,266.19	102	6
16"x9"x8'	\$1,083.70	46354		\$337.76	46355	\$1,421.46	143	6
16"x12"x6'	\$990.75	C1071606AC		\$402.35	C5251600	\$1,393.10	143	4
16"x12"x8'	\$1,222.07	C1071608AC		\$402.35	C5251600	\$1,624.42	143	4

- 10", 12", and 16" caps and bases are not interchangeable.
- All dimensions are nominal.
- Neck Mould included with column shaft but not applied.

Recessed Panel Square PermaCast® Plus Column List Pricing

Bottom Width X Height	Price	Shaft		Cap & Base Set		Complete Column Shaft & C/B Set Price	Wt. (lbs.)	Per Pallet
		Stock #		Price	Stock #			
8"x8'	\$690.78	46382		\$117.36	54301	\$808.14	116	20
8"x9'	\$791.30	46384		\$117.36	54301	\$908.66	129	20
8"x10'	\$806.97	46386		\$117.36	54301	\$924.33	142	20
10"x8'	\$869.28	46402		\$169.28	54305	\$1,038.56	130	16
10"x9'	\$1,023.50	46404		\$169.28	54305	\$1,192.78	146	16
10"x10'	\$1,044.62	46406		\$169.28	54305	\$1,213.90	165	16
12"x8'	\$1,348.82	46422		\$258.34	54309	\$1,607.17	180	9
12"x9'	\$1,490.36	46424		\$258.34	54309	\$1,748.71	202	9
12"x10'	\$1,627.67	46426		\$258.34	54309	\$1,886.02	250	9
12"x12'	\$1,892.79	46428		\$258.34	54309	\$2,151.14	320	9
12"x14'	\$2,705.73	46430		\$258.34	54309	\$2,964.07	390	N/A
14"x8'	\$2,522.20	46442		\$418.23	54313	\$2,940.43	240	6
14"x10'	\$2,634.89	46446		\$418.23	54313	\$3,053.12	308	6
14"x14'	\$3,848.77	46450		\$418.23	54313	\$4,267.00	445	N/A

- Recessed Panel cannot be split.
- Consider PVC for Split Recessed Panel
- PermaCast® Plus recessed panel columns need to be primed with a quality bonding primer, followed by a quality exterior acrylic latex top coat.



Phone: (800) 264-4HBG
 Fax: (334) 566-4629
 www.hbgcolumns.com

Square PermaCast® Plus Split Column List Pricing

Bottom Width X Height	Plain Split Shaft (Does Not Include Split Kit)		Fluted Split Shaft (Does Not Include Split Kit)		Split Kit		Split Cap & Base Set	
	Price	Stock #	Price	Stock #	Price	Stock #	Price	Stock #
6"x6'	\$414.08	45988S	N/A	N/A	\$102.55	17111	\$132.34	54297S
6"x8'	\$485.73	45990S	N/A	N/A	\$102.55	17111	\$132.34	54297S
6"x9'	\$553.17	45991S	N/A	N/A	\$102.55	17111	\$132.34	54297S
6"x10'	\$601.64	45992S	N/A	N/A	\$102.55	17111	\$132.34	54297S
8"x6'	\$489.95	46008S	N/A	N/A	\$102.55	17111	\$141.06	54301S
8"x8'	\$588.99	46010S	\$771.05	46210S	\$102.55	17111	\$141.06	54301S
8"x9'	\$641.68	46011S	\$913.65	46211S	\$102.55	17111	\$141.06	54301S
8"x10'	\$725.97	46012S	\$1,001.32	46212S	\$102.55	17111	\$141.06	54301S
8"x12'	\$891.40	46014S	N/A	N/A	\$152.24	17112	\$141.06	54301S
10"x51"	\$504.70	46026S	N/A	N/A	\$152.24	17112	\$205.39	54305S
10"x6'	\$643.78	46028S	N/A	N/A	\$152.24	17112	\$205.39	54305S
10"x8'	\$751.26	46030S	N/A	N/A	\$152.24	17112	\$205.39	54305S
10"x9'	\$832.39	46031S	N/A	N/A	\$152.24	17112	\$205.39	54305S
10"x10'	\$910.36	46032S	\$1,285.47	46232S	\$152.24	17112	\$205.39	54305S
10"x12'	\$1,083.16	46034S	N/A	N/A	\$152.24	17112	\$205.39	54305S
10"x14'	\$1,776.48	46036S	N/A	N/A	\$152.24	17112	\$205.39	54305S
10"x16'	\$2,023.04	46038S	N/A	N/A	\$152.24	17112	\$205.39	54305S
12"x8'	\$911.42	46050S	N/A	N/A	\$152.24	17112	\$309.16	54309S
12"x9'	\$1,011.88	46051S	N/A	N/A	\$152.24	17112	\$309.16	54309S
12"x10'	\$1,115.83	46052S	N/A	N/A	\$152.24	17112	\$309.16	54309S
12"x12'	\$1,299.17	46054S	N/A	N/A	\$152.24	17112	\$309.16	54309S
12"x14'	\$2,209.91	46056S	N/A	N/A	\$152.24	17112	\$309.16	54309S
12"x16'	\$2,369.58	46058S	N/A	N/A	\$152.24	17112	\$309.16	54309S
12"x18'	\$2,978.48	46060S	N/A	N/A	\$152.24	17112	\$309.16	54309S
14"x8'	\$1,679.54	46070S	N/A	N/A	\$152.24	17112	\$501.88	54313S
14"x10'	\$2,101.33	46072S	N/A	N/A	\$152.24	17112	\$501.88	54313S
14"x12'	\$2,638.90	46074S	N/A	N/A	\$152.24	17112	\$501.88	54313S
14"x14'	\$2,957.19	46076S	N/A	N/A	\$152.24	17112	\$501.88	54313S
16"x8'	\$2,132.20	46090S	N/A	N/A	\$152.24	17112	\$713.64	54317S
16"x10'	\$2,383.42	46092S	N/A	N/A	\$152.24	17112	\$713.64	54317S
16"x12'	\$2,700.65	46094S	N/A	N/A	\$152.24	17112	\$713.64	54317S
16"x14'	\$3,175.42	46096S	N/A	N/A	\$152.24	17112	\$713.64	54317S
16"x16'	\$3,321.25	46098S	N/A	N/A	\$152.24	17112	\$713.64	54317S
16"x18'	\$3,737.48	46100S	N/A	N/A	\$152.24	17112	\$713.64	54317S
16"x20'	\$4,090.89	46102S	N/A	N/A	\$152.24	17112	\$713.64	54317S

- Neck Mould included with Tuscan cap and base but not applied.
- Custom Split Columns (H and K patterns) - Add 20% to split list

17111, 17112
Non Flange Split Kit Includes
43" straps Adhesive*
4 - Aluminum Plates with Screws Installation Instructions



Phone: (800) 264-4HBG
 Fax: (334) 566-4629
 www.hbgcolumns.com

* MMA Adhesive has specific storage and handling requirements.

Craftsman Style PermaCast® Plus Split Column List Pricing

Bottom Width X Height	Plain Split Shaft		Split Kit		Split Cap & Base Set	
	Price	Stock #	Price	Stock #	Price	Stock #
10"X5.5"X66"	\$613.67	46358S	\$102.55	17111	\$179.99	46359S
10.25"x7.5"x7'	\$912.59	70061007PLS	\$102.55	17111	\$273.05	7062101002S
10"x8"x66"	\$740.72	C1071006ACS	\$102.55	17111	\$269.15	C525100S
12"X8"X5'	\$915.76	46332S	\$102.55	17111	\$286.93	46345S
12"X8"X6'	\$1,009.41	46334S	\$102.55	17111	\$286.93	46345S
12"X10"X6'	\$992.87	46336S	\$102.55	17111	\$322.93	46341S
12"X10"X10'*	\$1,255.87	46340S	\$102.55	17111	\$322.93	46341S
14"X12"X9'***	\$1,892.79	70061409PLS	\$152.24	17112	\$412.19	7062141402S
16"X9"X58"	\$670.12	46350S	\$152.24	17112	\$387.52	46351S
16"X9"X6'	\$1,011.88	46362S	\$152.24	17112	\$406.58	46355S
16"X9"X8'	\$1,204.12	46354S	\$152.24	17112	\$406.58	46355S
16"x12"x6'	\$1,189.33	C1071606ACS	\$152.24	17112	\$477.52	C5251600S
16"x12"x8'	\$1,465.01	C1071608ACS	\$152.24	17112	\$477.52	C5251600S

- 10", 12", and 16" caps and bases are not interchangeable
- All dimensions are nominal.
- Neck Mould included with column shaft but not applied.
- Installation Kit with flashing not included

17111 & 17112
Non Flange Split Kit Includes 43" straps Adhesive* 4 - Aluminum Plates with Screws Installation Instructions

* MMA Adhesive has specific storage and handling requirements.

PermaCast® Plus RoughSawn®

With the texture of rough sawn cedar and the strength of PermaCast® Plus, RoughSawn® delivers the beauty of wood without its inherent issues. Now available in Craftsman style.

RoughSawn® Pricing

Item	Shape	Stock #	Size	List Price	Pallet Quantities
Column	Square	47020	8" x 8'	\$468.10	20
	Square	47021	8" x 9'	\$506.03	20
	Square	47022	8" x 10'	\$546.12	20
	Square	47030	10" x 8'	\$591.63	16
	Square	47031	10" x 9'	\$651.23	16
	Square	47032	10" x 10'	\$709.75	16
	Square	47034	10" x 12'	\$841.95	12
	Square	47040	12" x 8'	\$735.75	9
	Square	47041	12" x 9'	\$815.94	9
	Square	47042	12" x 10'	\$887.46	9
	Square	47044	12" x 12'	\$1,033.74	6
	Craftsman	47110	10" x 6" x 66"	\$590.55	9
	Craftsman	47116	12" x 8" x 66"	\$788.85	6
Brace		660124		\$231.87	24"
Trim*	Square	660004		\$45.52	4"
	Square	660006		\$52.93	6"
	Craftsman/Square	660054**		\$68.81	4" Crafts

*Trim is 4 pieces of material. Enough for a cap or base. Works for all RoughSawn® Squares.

**Beveled trim for use with Craftsman RoughSawn®. Order A0262080 Install Kit as well. Must purchase separately for installation



Phone: (800) 264-4HBG
 Fax: (334) 566-4629
 www.hbgcolumns.com

Square PermaCast® Plus Accessories

PLAIN SQUARE PERMACAST® PLUS COLUMN PANEL MOULDING

Stock #	Length	List Price
54502	8'	\$43.34
54505	10'	\$53.91



8' = No. 54502 - 1/2" x 1"

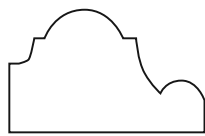

10' = No. 54505 - 3/4" x 15/16"

SQUARE PERMACAST® PLUS COLUMN NECK MOULD (Included with Tuscan C&B)

Stock #	Description	Size	Length	List Price
54498	For use with 6" and 8" Square PermaCast® Columns	1"	63"	\$31.71
54500	For use with 10" and 12" Square PermaCast® Columns	1"	63"	\$41.22
54501	For use with 14" and 16" and larger Square PermaCast® Columns	1-1/8"	63"	\$54.97
54496	Low Profile for PermaCast® Colonial Cap and Base Sets	1"	63"	\$31.71

Neck Moulding

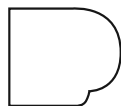

No. 54498 - 6" & 8" - 1" x 13/16"
Square Neck Mould

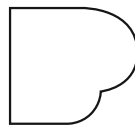

No. 54500 - 10" & 12" - 1" x 1-1/8"
Square Neck Mould



No. 54501 - 14" & 16" - 1-1/8" x 1-3/8"
Square Neck Mould



No. 54496 - 1" x 11/16"
Low Profile Neck Mould

SPECIAL NECK MOULD INSTRUCTIONS FOR SCAMOZZI, GREEK IONIC AND ROMAN IONIC CAPITALS FOR SQUARE PERMACAST® PLUS COLUMNS

OMITTING NECK MOULD – Because of the beaded rim at the base of these capitals, they may be installed without neck mould. The beaded edge serves the same purpose aesthetically as a neck mould. Standard installation instructions for capitals should be followed, omitting references to neck mould.

USING NECK MOULD –

If neck mould is to be used, it should be coped to fit around the scrolls of the capital. See appropriate illustration to the right.

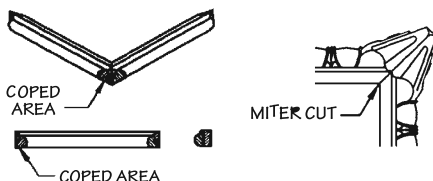

Without Neck Mould
-SCAMOZZI-

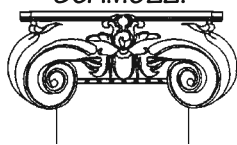

With Neck Mould
-SCAMOZZI-



10" Side View

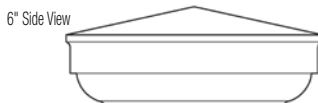

6" Side View

PYRAMID CAPS FOR PERMACAST® PLUS COLUMNS (For use when PermaCast® column is used as a newel)

Stock #	Description	List Price
03909	Pyramid Cap for use with 6" Square PermaCast® Plus as Newel	\$130.48
54351	Pyramid Cap for use with 10" Square PermaCast® Plus as Newel	\$165.17
45981	Pyramid Cap for use with 10" Round PermaCast® Plus as Newel	\$132.34
45985	Pyramid Cap for use with 10" No-Taper Round PermaCast® Plus as Newel	\$168.34

*6" is polyurethane, 10" is PVC

Perma-Loc®

This new uplift anchoring system from HB&G® is versatile, easy to install and affordable. The code compliant hardware kits provide the function needed to protect column supported projecting roof lines from wind uplift forces, while solving for common coastal challenges for residential, commercial and municipal installations. Exceeds the required capacity for 1,000 lb. uplift

Available SKUs

SKU	Description	Qty.	List Price
17150	12' Perma-Loc		\$237.88
17150MP	12' Perma-Loc Multi Pack 12 units		\$2,854.54
17151	16' Perma-Loc		\$259.02
17151MP	16' Perma-Loc Multi Pack 12 units		\$3,108.29
17152	20' Perma-Loc		\$281.23
17152MP	20' Perma-Loc Multi Pack 12 units		\$3,374.72

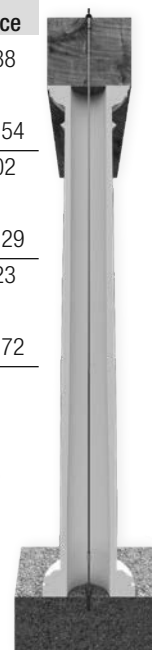

HB&G
BUILDING PRODUCTS

Phone: (800) 264-4HBG
Fax: (334) 566-4629
www.hbgcolumns.com

Decorative Capitals for Square PermaCast® Plus Columns List Pricing



Roman Ionic



Greek Ionic



Temple of the Winds



Roman Corinthian



Scamozzi



Tuscan Cap



Tuscan Base



Attic Base

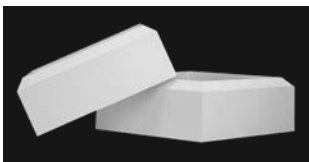

Beveled Cap and Base

Capital	6" Square		8" Square		10" Square		12" Square		16" Square	
	Price	Stock #	Price	Stock #	Price	Stock #	Price	Stock #	Price	Stock #
Roman Ionic	\$312.35	77592	\$339.97	77621	\$435.59	77622	\$607.71	77623	\$1,714.77	77625
Greek Ionic	\$312.35	77591	\$339.97	77641	\$435.59	77642	\$856.32	77643	\$1,714.77	77645
Temple of the Winds*	\$435.59	77595	\$536.52	77601	\$1,002.94	77602	\$1,492.72	77603	\$1,903.89	77605
Roman Corinthian*	\$749.01	77593	\$934.94	77631	\$1,492.72	77632	\$1,869.89	77633	\$2,941.90	77635
Scamozzi	\$376.09	77594	\$409.03	77611	\$607.71	77612	\$856.32	77613	\$2,022.88	77615

*Not recommended with fluted and recessed panel square PermaCast® columns

• Split charge for ornamental capitals: add 20% to list price.

• Custom splits - Add 20% to split list.

Features

- Molded from polyurethane resin.
- Lightweight for easy installation.
- Weather, rot, and insect proof.

Add 20% to Split - All Caps and Bases.

Decorative Capitals for SQUARE PermaCast® Plus Columns

Adding a decorative capital to a square PermaCast® column DOES NOT change the length of the column shaft. The decorative capital simply slides over the shaft. Neck moulding can be applied or not.

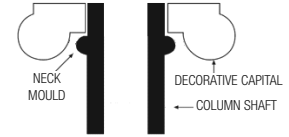

Caps and Bases for Square PermaCast® Plus Columns

Tuscan Caps and Bases for Square PermaCast® Plus Columns and Sets for Square PermaCast® Columns with No Installation Kit or Flashing

Column Size	Cap		Base		Set	
	Price	Stock #	Price	Stock #	Price	Stock #
6"	\$42.34	54300	\$64.58	54298	\$105.87	54700
8"	\$45.13	54304	\$68.83	54302	\$112.85	54702
10"	\$63.19	54308	\$103.82	54306	\$162.51	54704
12"	\$100.58	54312	\$149.28	54310	\$247.76	54706
14"	\$174.70	54316	\$229.76	54314	\$403.40	54708
16"	\$255.17	54320	\$316.58	54318	\$570.70	54710

Attic Base for Square PermaCast® Plus Columns

Column Size	Torus		Plinth		Set	
	Price	Stock #	Price	Stock #	Price	Stock #
6"	\$87.41	54395	\$57.17	54397	\$144.57	54398
8"	\$97.82	54401	\$63.52	54403	\$161.35	54404
10"	\$146.74	54405	\$111.17	54407	\$244.58	54408
12"	\$168.27	54409	\$136.58	54411	\$304.85	54412
16"	\$263.33	54417	\$291.17	54419	\$554.50	54420

Cap and Base for Craftsman PermaCast® Plus Columns

Column Size	Cap		Base	
	Price	Stock #	Price	Stock #
10" x 5.5" x 66"	\$52.93	46361	\$96.34	46360
12" x 10" x 6' & 10'	\$97.40	46343	\$170.46	46342
16" x 9" x 58"	\$60.34	46353	\$279.52	46352
16" x 9" x 8'	\$60.34	46353	\$279.52	46356
16" x 9" x 6'	\$60.34	46353	\$279.52	46356

**PermaPrimed caps and bases have two full coats of primer

• Split Charge for individual cap or base: add 20% to list price

• Split Charge for special cuts: add 20% to split list price

PermaCast® Plus Craftsman Beveled Cap and Base (L-Shaped)

Size	Cap		Base		Set	
	Stock #	List Price	Stock #	List Price	Stock #	List Price
10"x5.5"	\$33.99	46501	\$50.99	46503	\$81.99	46504
10.25"x7.5"	\$34.99	46505	\$53.99	46507	\$86.99	46508
10"x8"	\$34.99	46505	\$52.99	46511	\$85.99	46512
12"x8"	\$35.99	46513	\$54.99	46515	\$90.99	46516
12"x10"	\$39.99	46517	\$58.99	46519	\$97.99	46520
14"x12"	\$41.99	46521	\$59.99	46523	\$98.99	46524
16"x9"x5.8"	\$41.99	46525	\$60.99	46527	\$100.99	46528
16"x9"	\$41.99	46529	\$60.99	46531	\$100.99	46532
16"x12"	\$43.99	46533	\$61.99	46535	\$103.99	46536

HD Poly Base with Poly Cap*

Size	List Price	Stock #
8"	\$189.52	54372
10"	\$243.52	54374
12"	\$365.29	54376

*No Flashing Cap or Installation Kit

Colonial Cap & Base Sets for Square PermaCast® Plus

Column Size	Set	
	Price	Stock #
6"	\$91.05	45091
8"	\$96.34	46081
10"	\$137.64	46141
12"	\$212.81	46261

*Low profile cap and base for railing applications

Polyurethane Crown Caps

Column Size	Set	
	Price	Stock #
6"	\$84.61	61061
8"	\$100.09	61062
10"	\$139.31	61063
12"	\$203.29	61064

PermaCast® Plus Square Beveled Cap & Base Sets*

Column Size	List Price	Stock #
6"	\$92.86	54800
8"	\$107.99	54802
10"	\$133.30	54804
12"	\$152.29	54806

*Use Installation Kit A0262080; sold separately

*Use an X suffix when ordering split cap and base sets for PermaWrap®



Phone: (800) 264-4HBG
Fax: (334) 566-4629
www.hbgcolumns.com

Predesigned PermaWrap® Column List Pricing

Plain Non-Tapered PermaWrap® Column List Pricing

Width	Height	Value (2 L-Shaped Halves)				Premium (2 L-Shaped Halves)				Pallet Qty
		Standard Cap & Base		Ogee Cap & Base		Standard Cap & Base		Ogee Cap & Base		
		Price	Stock #	Price	Stock #	Price	Stock #	Price	Stock #	
6"	6'	\$325.07	84310	\$334.36	85410	\$371.51	86210	\$380.80	86250	24
	8'	\$368.41	84311	\$375.64	85411	\$426.21	86211	\$434.46	86251	24
	9'	\$391.12	84312	\$397.31	85412	\$456.13	86212	\$465.42	86252	24
	10'	\$411.76	84313	\$420.01	85413	\$485.03	86213	\$493.29	86253	24
	12"	\$519.09	84314	\$527.34	85414	\$541.79	86214	\$552.11	86254	20
8"	6'	\$386.99	84315	\$394.21	85415	\$449.94	86215	\$457.17	86255	20
	8'	\$434.46	84316	\$441.69	85416	\$519.09	86216	\$527.34	86256	20
	9'	\$460.26	84320	\$468.52	85417	\$552.11	86220	\$559.33	86260	20
	10'	\$482.97	84321	\$490.19	85421	\$584.10	86221	\$592.36	86261	20
	12'	\$529.41	84323	\$536.63	85423	\$649.12	86223	\$659.44	86263	16
10"	6'	\$452.01	84325	\$460.26	85425	\$525.28	86225	\$534.57	86265	16
	8'	\$506.70	84326	\$517.02	85426	\$602.68	86226	\$609.90	86266	16
	9'	\$539.73	84327	\$547.98	85427	\$659.44	86227	\$665.63	86267	16
	10'	\$569.65	84331	\$575.85	85431	\$683.17	86231	\$693.49	86271	16
	12'	\$640.86	84333	\$649.12	85433	\$789.47	86233	\$796.69	86273	12
12"	6'	\$499.48	84335	\$506.70	85435	\$596.49	86235	\$603.71	86275	9
	8'	\$554.17	84336	\$563.46	85436	\$675.95	86236	\$683.17	86276	9
	9'	\$581.01	84337	\$588.23	85437	\$718.26	86237	\$728.58	86277	9
	10'	\$606.81	84341	\$615.06	85441	\$760.57	86241	\$767.80	86281	9
	12'	\$659.44	84343	\$665.63	85443	\$844.17	86234	\$852.42	86283	9

NOTE: Value utilizes 3/8" PVC and Premium utilizes 1/2" PVC shaft. Ogee C&B utilizes 5/8" PVC. Standard C&B utilizes 3/8" PVC.

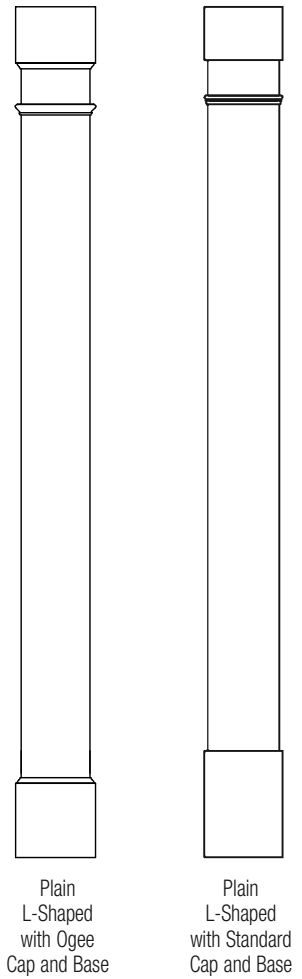
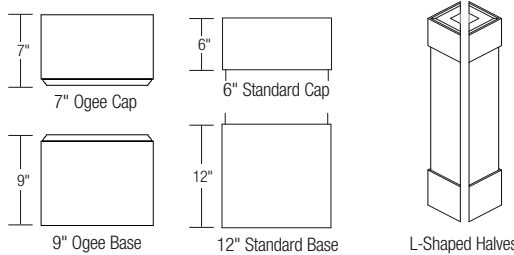

Woodgrain Non-Tapered PermaWrap® Column List Pricing

Width	Height	Standard Price	Stock #
6"	8'	\$ 356.99	88400
	9'	\$ 378.99	88401
	10'	\$ 398.99	88402
8"	8'	\$ 427.99	88406
	9'	\$ 453.99	88407
	10'	\$ 474.99	88408
10"	9'	\$ 539.73	88413
	10'	\$ 557.99	88414



Realistic embossed woodgrain pattern



Phone: (800) 264-4HBG
 Fax: (334) 566-4629
 www.hbgcolumns.com

Predesigned PermaWrap® Column List Pricing

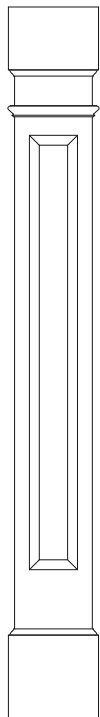

Raised Panel L-Shaped with Ogee Cap and Base

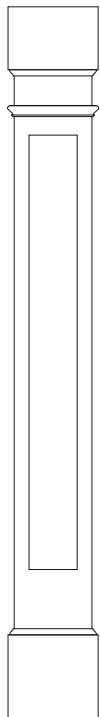

Recessed Panel L-Shaped with Ogee Cap and Base

Raised Panel Non-Tapered PermaWrap® Column List Pricing (2 L-Shaped Halves)

Size	Height	Raised Panel		Raised Panel 36"		Raised Panel 42"		Triple Raised Panel		Pallet Qty
		Price	Stock #	Price	Stock #	Price	Stock #	Price	Stock #	
6"	6'	\$402.47	84107	\$402.47	84707	\$402.47	84747	\$402.47	84807	24
	8'	\$467.49	84109	\$467.49	84709	\$467.49	84749	\$467.49	84809	24
	9'	\$504.64	84110	\$504.64	84710	\$504.64	84750	\$504.64	84810	24
	10'	\$536.63	84111	\$536.63	84711	\$536.63	84751	\$536.63	84811	24
	12'	\$602.68	84113	\$602.68	84713	\$602.68	84753	\$602.68	84813	20
8"	6'	\$477.81	84115	\$477.81	84715	\$477.81	84755	\$477.81	84815	20
	8'	\$554.17	84116	\$554.17	84716	\$554.17	84756	\$554.17	84816	20
	9'	\$596.49	84117	\$596.49	84717	\$596.49	84757	\$596.49	84817	20
	10'	\$631.57	84121	\$631.57	84721	\$631.57	84761	\$631.57	84818	20
	12'	\$707.94	84123	\$707.94	84723	\$707.94	84763	\$707.94	84819	16
10"	6'	\$554.17	84125	\$554.17	84725	\$554.17	84765	\$554.17	84825	16
	8'	\$642.93	84126	\$642.93	84726	\$642.93	84766	\$642.93	84826	16
	9'	\$686.27	84127	\$686.27	84727	\$686.27	84767	\$686.27	84827	16
	10'	\$730.65	84131	\$730.65	84728	\$730.65	84768	\$730.65	84828	16
	12'	\$815.27	84133	\$815.27	84733	\$815.27	84773	\$815.27	84833	12
12"	6'	\$616.09	84135	\$616.09	84735	\$616.09	84775	\$616.09	84835	9
	8'	\$707.94	84136	\$707.94	84736	\$707.94	84776	\$707.94	84836	9
	9'	\$751.29	84137	\$751.29	84737	\$751.29	84777	\$751.29	84837	9
	10'	\$795.66	84141	\$795.66	84741	\$795.66	84781	\$795.66	84841	9
	12'	\$888.54	84143	\$888.54	84743	\$888.54	84783	\$888.54	84843	6

NOTE: 1/2" PVC with 5/8" Ogee Cap and Base

Recessed Panel Non-Tapered PermaWrap® Column List Pricing (2 L-Shaped Halves)

Size	Height	Recessed Panel		Recessed Panel 36"		Recessed Panel 42"		Triple Recessed Panel		Pallet Qty
		Price	Stock #	Price	Stock #	Price	Stock #	Price	Stock #	
6"	6'	\$588.23	84007	\$588.23	84507	\$588.23	84547	\$588.23	84607	24
	8'	\$650.15	84009	\$650.15	84509	\$650.15	84549	\$650.15	84609	24
	9'	\$698.65	84010	\$698.65	84510	\$698.65	84550	\$698.65	84610	24
	10'	\$745.09	84011	\$745.09	84511	\$745.09	84551	\$745.09	84611	24
	12'	\$844.17	84013	\$844.17	84513	\$844.17	84553	\$844.17	84613	20
8"	6'	\$703.81	84015	\$703.81	84515	\$703.81	84555	\$703.81	84615	20
	8'	\$803.92	84016	\$803.92	84516	\$803.92	84556	\$803.92	84616	20
	9'	\$875.13	84017	\$875.13	84517	\$875.13	84557	\$875.13	84617	20
	10'	\$943.24	84021	\$943.24	84521	\$943.24	84561	\$943.24	84621	20
	12'	\$1,076.37	84023	\$1,076.37	84523	\$1,076.37	84563	\$1,076.37	84623	16
10"	6'	\$785.34	84025	\$785.34	84525	\$785.34	84565	\$785.34	84625	16
	8'	\$951.49	84026	\$951.49	84526	\$951.49	84566	\$951.49	84626	16
	9'	\$1,034.05	84027	\$1,034.05	84527	\$1,034.05	84567	\$1,034.05	84627	16
	10'	\$1,114.55	84031	\$1,114.55	84531	\$1,114.55	84571	\$1,114.55	84631	16
	12'	\$1,278.64	84033	\$1,278.64	84533	\$1,278.64	84573	\$1,278.64	84633	12
12"	6'	\$872.03	84035	\$872.03	84535	\$872.03	84575	\$872.03	84635	9
	8'	\$1,044.37	84036	\$1,044.37	84536	\$1,044.37	84576	\$1,044.37	84636	9
	9'	\$1,134.16	84037	\$1,134.16	84537	\$1,134.16	84577	\$1,134.16	84637	9
	10'	\$1,221.88	84041	\$1,221.88	84541	\$1,221.88	84581	\$1,221.88	84641	9
	12'	\$1,394.22	84043	\$1,394.22	84543	\$1,394.22	84583	\$1,394.22	84643	6

NOTE: 1/2" PVC with 5/8" Ogee Cap and Base



Phone: (800) 264-4HBG
 Fax: (334) 566-4629
 www.hbgcolumns.com

Predesigned PermaWrap® Column List Pricing

Craftsman Tapered PermaWrap® Column List Pricing (2 L-Shaped Halves)

Size	Height	Plain Value		Plain Premium		Raised Panel		Recessed Panel		Pallet Qty
		w/ Traditional C&B Price	Stock #	w/ Traditional C&B Price	Stock #	w/ Traditional C&B Price	Stock #	w/ Traditional C&B Price	Stock #	
10"x6"	48"	\$404.53	86371	\$456.13	86201	N/A	N/A	\$704.24		6
	54"	\$420.01	86372	\$461.29	86202	N/A	N/A	\$781.58		6
	60"	\$437.56	86373	\$485.03	86203	N/A	N/A	\$781.58		6
	66"	\$459.23	86374	\$517.02	86204	N/A	N/A	\$858.90		6
	72"	\$471.61	86375	\$533.53	86205	N/A	N/A	\$858.90		6
	84"	\$504.64	86376	\$592.36	86206	N/A	N/A	\$936.62		6
	96"	\$536.63	86377	\$649.12	86207	N/A	N/A	\$1,013.94		6
	108"	\$574.81	86378	\$701.75	86208	N/A	N/A	\$1,100.20		6
	120"	\$614.03	86379	\$750.25	86209	N/A	N/A	\$1,166.83		6
12"x8"	48"	\$445.81	86381	\$501.54	83128	\$559.33	83228	\$751.29	83328	6
	54"	\$467.49	86382	\$520.12	83130	\$596.49	83230	\$795.66	83330	6
	60"	\$486.06	86383	\$547.98	83132	\$631.57	83232	\$831.78	83332	6
	66"	\$517.02	86384	\$588.23	83134	\$669.76	83234	\$877.19	83334	6
	72"	\$525.28	86385	\$603.71	83136	\$704.85	83236	\$914.34	83336	6
	84"	\$568.62	86386	\$669.76	83137	\$776.05	83237	\$1,018.57	83337	6
	96"	\$606.81	86387	\$735.81	83138	\$847.26	83238	\$1,119.71	83338	6
	108"	\$650.15	86388	\$815.27	83176	\$943.24	83239	\$1,236.33	83339	6
	120"	\$684.21	86389	\$882.35	83178	\$1,020.64	83240	\$1,355.01	83340	6
16"x10"	48"	N/A	N/A	\$616.09	83143	\$643.96	83241	\$852.42	83341	4
	54"	N/A	N/A	\$636.73	83142	\$715.17	83242	\$910.21	83342	4
	60"	N/A	N/A	\$671.82	83144	\$754.38	83244	\$956.65	83344	4
	66"	N/A	N/A	\$716.20	83146	\$795.66	83246	\$1,008.25	83346	4
	72"	N/A	N/A	\$749.22	83148	\$835.91	83248	\$1,059.85	83348	4
	84"	N/A	N/A	\$818.37	83149	\$920.53	83249	\$1,192.98	83349	4
	96"	N/A	N/A	\$883.38	83150	\$1,001.03	83250	\$1,323.01	83350	4
	108"	N/A	N/A	\$971.10	83151	\$1,092.88	83251	\$1,415.89	83351	4
	120"	N/A	N/A	\$1,046.44	83152	\$1,175.44	83252	\$1,594.43	83352	4
20"x15"	48"	N/A	N/A	\$749.22	83153	\$823.53	83253	\$990.71	83353	4
	54"	N/A	N/A	\$792.57	83154	\$878.22	83254	\$1,059.85	83354	4
	60"	N/A	N/A	\$835.91	83156	\$925.69	83256	\$1,119.71	83356	4
	66"	N/A	N/A	\$877.19	83158	\$978.33	83258	\$1,189.89	83358	4
	72"	N/A	N/A	\$920.53	83160	\$1,029.93	83260	\$1,244.58	83360	4
	84"	N/A	N/A	\$1,003.09	83161	\$1,133.13	83261	\$1,406.61	83361	4
	96"	N/A	N/A	\$1,088.75	83162	\$1,235.29	83262	\$1,560.37	83362	4
	108"	N/A	N/A	\$1,188.85	83163	\$1,330.24	83263	\$1,790.51	83363	4
	120"	N/A	N/A	\$1,289.99	83166	\$1,427.25	83265	\$2,020.65	83365	4
24"x16"	48"	N/A	N/A	\$847.26	86391	\$896.80	86401	\$1,196.08	86411	1
	54"	N/A	N/A	\$893.70	86392	\$979.36	86402	\$1,283.80	86412	1
	60"	N/A	N/A	\$940.14	86393	\$1,035.09	86403	\$1,370.49	86413	1
	66"	N/A	N/A	\$985.55	86394	\$1,090.81	86404	\$1,460.27	86414	1
	72"	N/A	N/A	\$1,030.96	86395	\$1,144.48	86405	\$1,549.02	86415	1
	84"	N/A	N/A	\$1,122.81	86396	\$1,254.90	86406	\$1,685.25	86416	1
	96"	N/A	N/A	\$1,213.62	86397	\$1,366.36	86407	\$1,813.21	86417	1
	108"	N/A	N/A	\$1,327.14	86398	\$1,457.17	86408	\$1,941.18	86418	1
	120"	N/A	N/A	\$1,427.25	86399	\$1,529.41	86409	\$2,068.12	86419	1

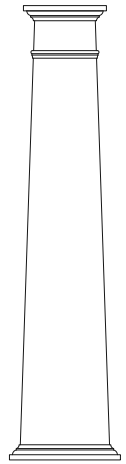

Plain Craftsman (L-Shaped) with Traditional Cap and Base

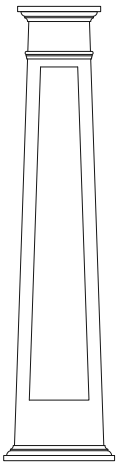

Recessed Panel Craftsman (L-Shaped) with Traditional Cap and Base

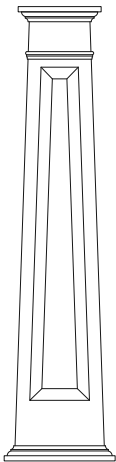

Raised Panel Craftsman (L-Shaped) with Traditional Cap and Base

NOTE: Value utilizes 3/8" PVC and Premium, Raised Panel, and Recessed Panel utilizes 1/2" PVC.

Predesigned PermaWrap® Column List Pricing

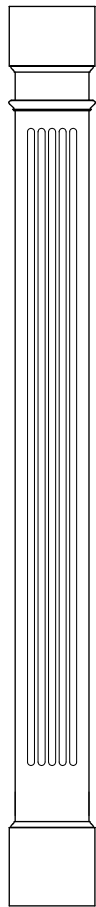

Fluted L-Shaped with Ogee Cap and Base

Fluted Non-Tapered PermaWrap® Column List Pricing (2 L-Shaped Halves)

Width	Height	Fluted		Double Fluted 36"		Double Fluted 42"		Pallet Qty
		Price	Stock #	Price	Stock #	Price	Stock #	
6"	6'	\$402.47	84210	\$402.47	84410	\$402.47	84450	24
	8'	\$467.49	84211	\$467.49	84411	\$467.49	84451	24
	9'	\$504.64	84212	\$504.64	84412	\$504.64	84452	24
	10'	\$536.63	84213	\$536.63	84413	\$536.63	84453	24
	12'	\$602.68	84214	\$602.68	84414	\$602.68	84454	20
8"	6'	\$477.81	84215	\$477.81	84415	\$477.81	84455	20
	8'	\$554.17	84216	\$554.17	84416	\$554.17	84456	20
	9'	\$596.49	84217	\$596.49	84417	\$596.49	84457	20
	10'	\$631.57	84221	\$631.57	84421	\$631.57	84461	20
	12'	\$707.94	84223	\$707.94	84423	\$707.94	84463	16
10"	6'	\$554.17	84225	\$554.17	84425	\$554.17	84465	16
	8'	\$642.93	84226	\$642.93	84426	\$642.93	84466	16
	9'	\$686.27	84227	\$686.27	84427	\$686.27	84467	16
	10'	\$730.65	84231	\$730.65	84431	\$730.65	84471	16
	12'	\$815.27	84233	\$815.27	84433	\$815.27	84473	12
12"	6'	\$616.09	84235	\$616.09	84435	\$616.09	84475	9
	8'	\$707.94	84236	\$707.94	84436	\$707.94	84476	9
	9'	\$751.29	84237	\$751.29	84437	\$751.29	84477	9
	10'	\$795.66	84241	\$795.66	84441	\$795.66	84481	9
	12'	\$888.54	84243	\$888.54	84443	\$888.54	84483	6

NOTE: 1/2" PVC with 5/8" Ogee Cap and Base.

PVC Pedestal List Pricing (2 L-Shaped Halves)

Size	Height	Plain w/ Traditional C&B		Raised Panel w/ Traditional C&B		Recessed Panel w/ Traditional C&B		Pallet Qty
		Price	Stock #	Price	Stock #	Price	Stock #	
12"	40'	\$541.79	86420	\$572.75	86430	\$749.22	83080	4
12"	46"	\$650.15	86421	\$660.47	86431	\$862.74	83081	4
16"	40'	\$662.53	86422	\$672.85	83102	\$927.76	83082	4
16"	46"	\$763.67	86423	\$773.99	83110	\$1,057.79	83090	4
20"	40'	\$776.05	86424	\$786.37	83104	\$1,122.81	83084	4
20"	46"	\$897.83	86425	\$900.93	83112	\$1,284.83	83092	4
24"	40'	\$875.13	86426	\$896.80	83106	\$1,302.37	83086	1
24"	46"	\$1,019.61	86427	\$1,029.93	83114	\$1,496.39	83093	1

NOTE: 1/2" PVC with traditional Cap and Base.

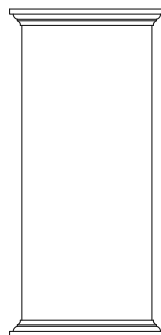

Plain

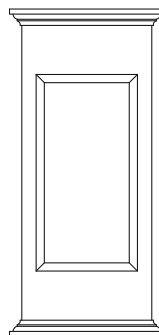

Raised Panel

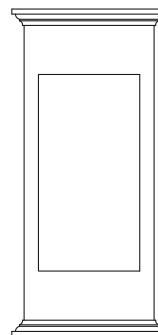

Recessed Panel

Features

- 25 Year Warranty
- Interior or Exterior Use
- Paintable Cellular PVC
- Installation Kit Included
- Price Includes Cap and Base

What You Need To Know

- A complete column consists of shaft, neck moulding, cap, and base.
- Optional Polyurethane caps and bases must be split.
- PermaWrap® columns used outside cannot be painted dark colors.
- See page 24 for additional cap and base options.
- Must be painted.



Phone: (800) 264-4HBG
 Fax: (334) 566-4629
 www.hbgcolumns.com

PermaSnap™ Column List Pricing

PermaSnap™ PVC Column Wrap List Pricing

STOCK #	Description & Nominal Dimensions	Actual Outside Dimensions	Suggested Retail Price Each
PS485	PERMASNAP™ 4"x4"x8.6'	4 3/4"x4 3/4"x8.6'	\$184.72
PS410	PERMASNAP™ 4"x4"x10'	4 3/4"x4 3/4"x10'	\$216.71
PS685	PERMASNAP™ 6"x6"x8.5'	6 3/4"x6 3/4"x8.6'	\$257.99
PS610	PERMASNAP™ 6"x6"x10'	6 3/4"x6 3/4"x10'	\$275.53
PS885	PERMASNAP™ 8"x8"x8.5'	9 1/2"x9 1/2"x8.6'	\$359.13
PS810	PERMASNAP™ 8"x8"x10'	9 1/2"x9 1/2"x10'	\$393.18
PS1085	PERMASNAP™ 10"x10"x8.5'	11 1/2"x11 1/2"x8.6'	\$383.89
PS1010	PERMASNAP™ 10"x10"x10'	11 1/2"x11 1/2"x10'	\$417.95

NOTE: PermaSnap™ is 3/8" PVC, ships flat and is designed to be installed around a treated wood or metal post. Parts sold separately; flexible, patented design.

PERMASNAP™ CAP AND BASE TRIM KITS

STOCK #	Description & Nominal Dimensions	Actual Outside Dimensions	Suggested Retail Price Each
BM404	4" Bed Mould	7"	\$25.79
BM606	5" Bed Mould	9"	\$29.92
BM808	8" Bed Mould	11 3/4"	\$31.98
BM1010	10" Bed Mould	13 3/4"	\$38.17
TK4HAM	4" Hampton Trim Kit	6 7/8"	\$67.07
TK6HAM	6" Hampton Trim Kit	8 7/8"	\$72.23
TK8HAM	8" Hampton Trim Kit	11 5/8"	\$81.52
TK10HAM	10" Hampton Trim Kit	13 5/8"	\$91.84
TK4CHE	4" Chesapeake Trim Kit	6 1/8"	\$79.45
TK6CHE	6" Chesapeake Trim Kit	8 1/8"	\$89.77
TK8CHE	8" Chesapeake Trim Kit	10 7/8"	\$100.09
TK10CHE	10" Chesapeake Trim Kit	12 7/8"	\$112.48
BM406	4" Bed Mould XL	8 3/8"	\$26.82
BM608	6" Bed Mould XL	10 3/8"	\$30.95
BM810	8" Bed Mould XL	13 1/8"	\$36.11
BM1012	10" Bed Mould XL	15 1/8"	\$40.24
NM400	4" Neck Mould	5 5/8"	\$23.73
NM600	6" Neck Mould	7 5/8"	\$28.89
NM800	8" Neck Mould	10 3/8"	\$30.95
NM1000	10" Neck Mould	12 3/8"	\$37.14

PermaSnap™ Accessories

Stock #	Description & Nominal Dimensions	List Price
PS4CAPC	4" Charleston Post Cap	\$76.36
PS4CAPW	4" Wilmington Post Cap	\$76.36
PS4CAPA	6" Ashbury Post Cap	\$100.09

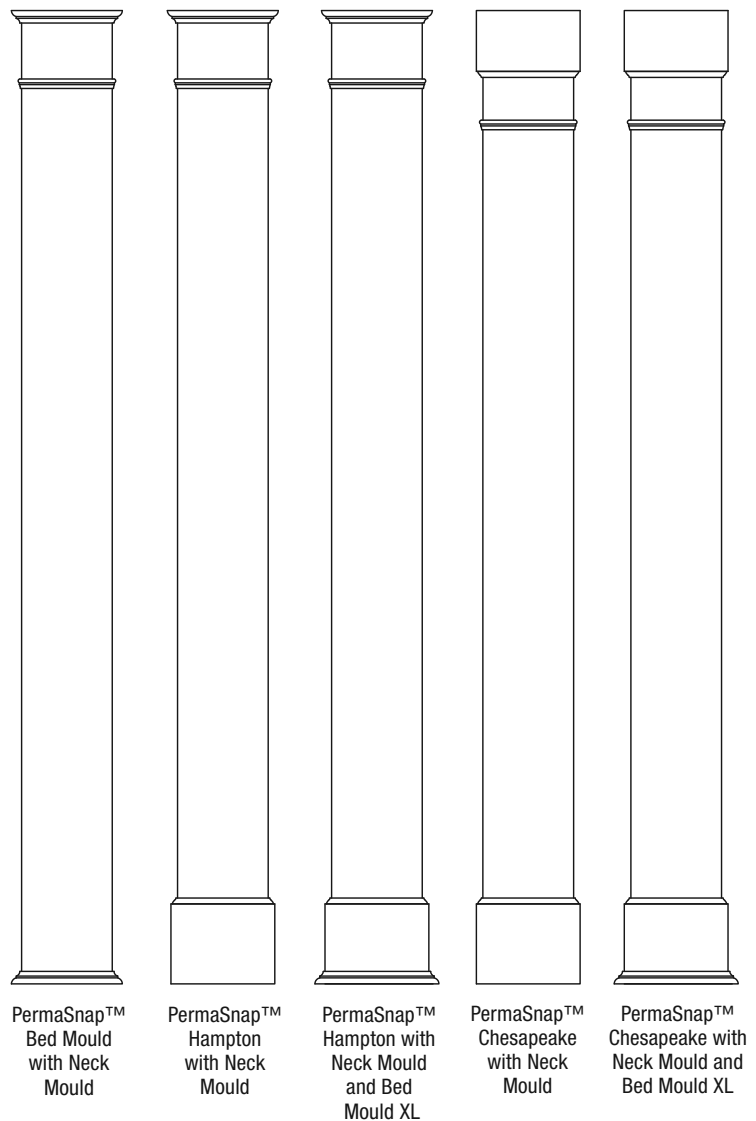

Phone: (800) 264-4HBG
 Fax: (334) 566-4629
 www.hbgcolumns.com

Caps and Bases for PermaWrap® Square Column List Pricing



Tuscan Cap



Tuscan Base

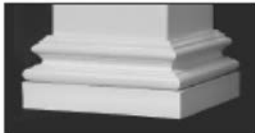

Attic Base



Crown Cap



Traditional Style

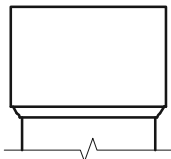

Ogee Style

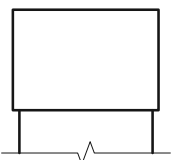

Standard Style



Beveled Cap and Base

Polyurethane Tuscan Caps and Bases for Square Columns split for PermaWrap

Column Width	Cap		Base	
	Price	Stock #	Price	Stock #
6"	\$49.24	54300X	\$75.91	54298X
8"	\$49.24	54304X	\$75.91	54302X
10"	\$69.76	54308X	\$113.88	54306X
12"	\$116.95	54312X	\$174.41	54310X

*No flashing cap or installation kit included.

Polyurethane Crown Cap split for PermaWrap

Column Width	Cap	
	Price	Stock #
6"	\$121.83	61061X
8"	\$144.12	61062X
10"	\$200.60	61063X
12"	\$292.73	61064X

Polyurethane Caps and bases must be split.

Polyurethane Attic Base for Square Columns split for PermaWrap

Column Width	Torus		Plinth		Set	
	Price	Stock #	Price	Stock #	Price	Stock #
6"	\$121.96	54395X	\$82.32	54397X	\$204.28	54398X
8"	\$128.06	54401X	\$91.47	54403X	\$219.52	54404X
10"	\$192.09	54405X	\$160.08	54407X	\$352.16	54408X
12"	\$234.79	54409X	\$196.67	54411X	\$431.46	54412X

Polyurethane Caps and bases must be split

PVC C&B sets shipped in 4 pieces

3/8" Cellular PVC Standard Style

Column Width	Cap and Base Set Price	Stock #
6"	\$103.19	61040
8"	\$112.48	61042
10"	\$126.93	61046
12"	\$133.12	61048

5/8" Cellular PVC Ogee Style

Column Width	Cap and Base Set Price	Stock #
6"	\$112.48	84060
8"	\$119.70	84062
10"	\$135.18	84064
12"	\$142.41	84066

Cellular PVC Traditional Style

Column Width	Cap and Base Set Price	Stock #
6"	\$102.16	84280
8"	\$112.48	84281
10"	\$123.83	84282
12"	\$130.02	84283

Beveled Cap & Base

Column Size	List Price	Stock #
6"	\$133.71	54800X
8"	\$155.50	54802X
10"	\$191.94	54804X
12"	\$224.99	54806X

Traditional Style Cap and 5/8" Ogee Style Base

Column Size	Cap and Base Set List Price	Stock #
6"	\$105.25	84286
8"	\$115.57	84287
10"	\$127.96	84288
12"	\$134.15	84289



Phone: (800) 264-4HBG
 Fax: (334) 566-4629
 www.hbgcolumns.com

Square PermaWrap® Custom Quote Form



"If You Dream It, We Can Build It"

Build Your Own Square PermaWrap® Column

Quote Request Form

Fill out the form below and fax to 334.566.4629. HB&G will contact you with a quote and put you in touch with a distributor based on your contact information.

Name: _____ Phone: _____ Fax: _____

City, State: _____ Date: _____ Email: _____

Column Size

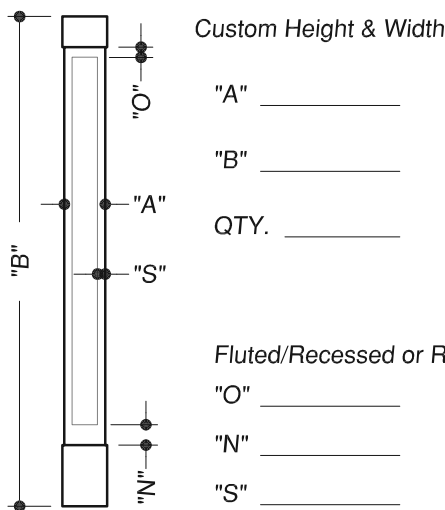

Shaft Design

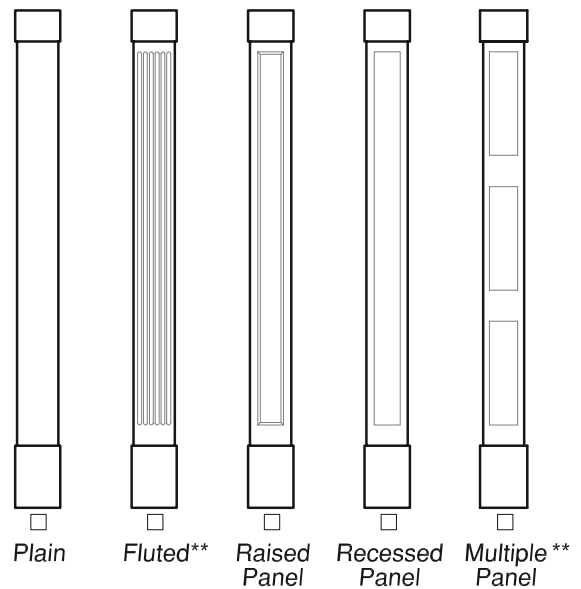

Need to further customize?

Please draw your custom column on backside of request form.

Pilaster return depth _____

**For multiple panels or flutes, please draw your custom column with dimensions on the back of this form..
2 L-shaped halves unless noted.

Half Column/Cap Options

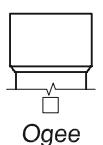
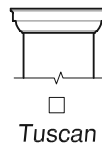
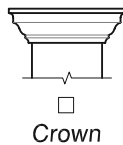
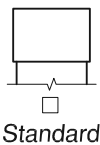

Base Options

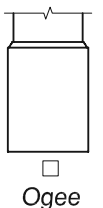
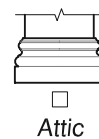
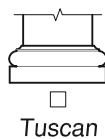
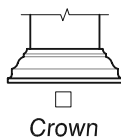
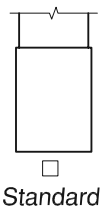

Predesigned PVC columns cost less and have shorter lead times.

Please fax the completed form to Customer Service at 334.566.4629

All units are in inches unless otherwise noted.

1015 Brundidge Blvd. • P.O. Box 589 • Troy, Alabama 36081 • 334.566.5000 • Fax 334.566.4629 • www.hbgcolumns.com

Square PermaWrap® Custom Quote Form



Build Your Own Square PermaWrap® Column

Quote Request Form

Draw Your Custom Paneled or Fluted Column

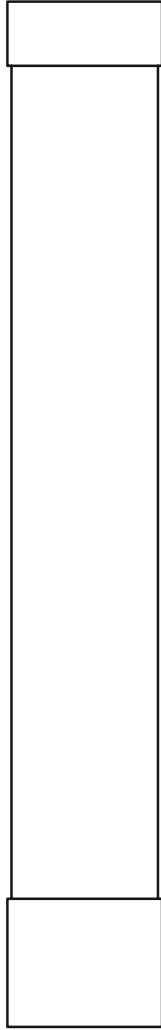

Draw Your Custom Panels or Flutes

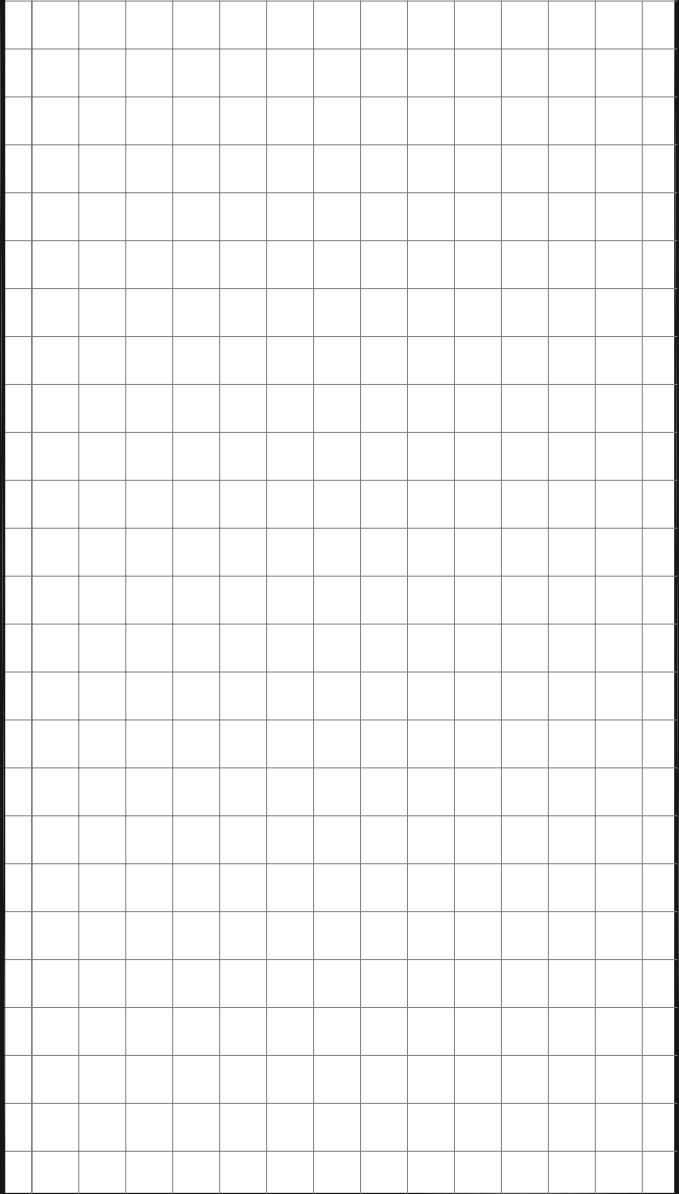

Description

Predesigned PVC columns cost less and have shorter lead times.

Please fax the completed form to Customer Service at 334.566.4629

All units are in inches unless otherwise noted.

1015 Brundidge Blvd. • P.O. Box 589 • Troy, Alabama 36081 • 334.566.5000 • Fax 334.566.4629 • www.hbgcolumns.com

Craftsman PermaWrap® Custom Quote Form



"If You Dream It, We Can Build It"

Build Your Own Square Craftsman PermaWrap® Column

Quote Request Form

Fill out the form below and fax to 334.566.4629. HB&G will contact you with a quote and put you in touch with a distributor based on your contact information.

Name: _____

Phone: _____

City, State: _____

Fax: _____

Date: _____

Email: _____

Column Size

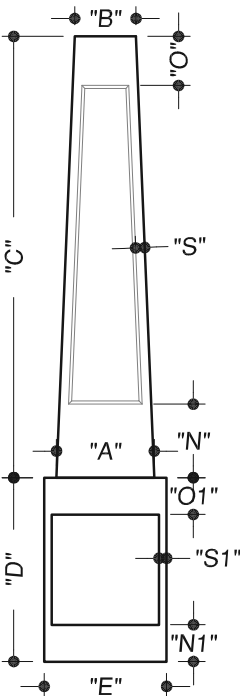

"A" _____

"B" _____

"C" _____

QTY. _____

Recessed/Raised Panels

"O" _____

"N" _____

"S" _____

Pedestal

"D" _____

"E" _____

"O1" _____

"N1" _____

"S1" _____

Pilaster returns _____

Shaft Design



Plain



Raised Panel



Recessed Panel

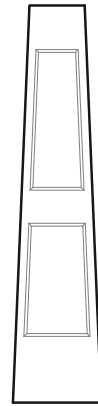

Multiple**

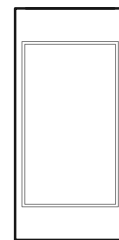

Raised Panel Pedestal



Recessed Panel Pedestal

Need to further customize?

Please draw your custom column on backside of request form.

Cap & Base Options

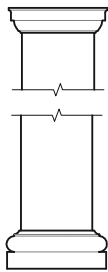

Tuscan

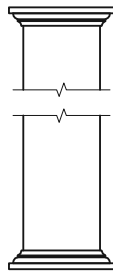

Traditional

Predesigned PVC columns cost less and have shorter lead times.

Please fax the completed form to Customer Service at 334.566.4629

All units are in inches unless otherwise noted.

1015 Brundidge Blvd. • P.O. Box 589 • Troy, Alabama 36081 • 334.566.5000 • Fax 334.566.4629 • www.hbgcolumns.com

Craftsman PermaWrap® Custom Quote Form



Build Your Own Square Craftsman PermaWrap® Column

Quote Request Form

Draw Your Custom Paneled or Fluted Column

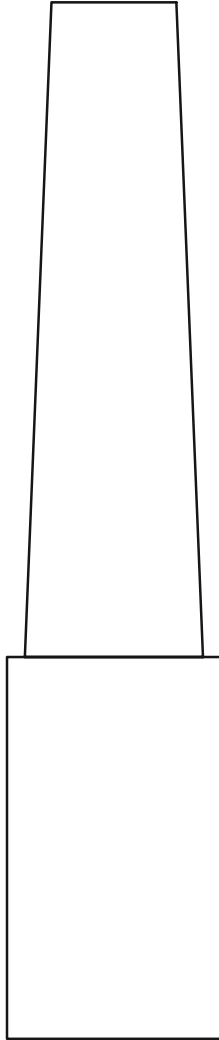

Draw Your Custom Panels

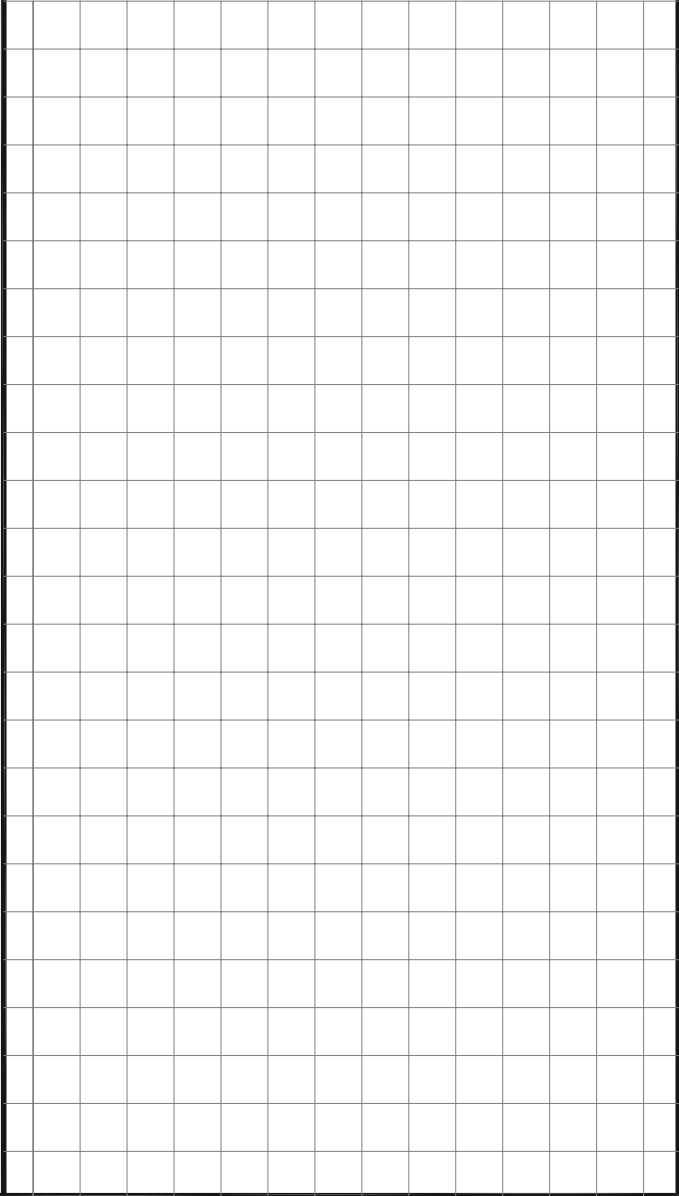

Description

Predesigned PVC columns cost less and have shorter lead times.

Please fax the completed form to Customer Service at 334.566.4629

All units are in inches unless otherwise noted.

1015 Brundidge Blvd. • P.O. Box 589 • Troy, Alabama 36081 • 334.566.5000 • Fax 334.566.4629 • www.hbgcolumns.com

Square PermaLite® Column List Pricing

Width X Height	Plain Shaft		Tuscan Cap & Base Set With neck Mould		Column Shaft & C/B Set Price	Wt. (lbs.)
	Price	Stock #	Price	Stock #		
6"x6'	\$249.82	80120606SP	\$89.28	8048060602	\$339.09	20
6"x8'	\$277.93	80120608SP	\$89.28	8048060602	\$367.21	22
6"x9'	\$309.30	80120609SP	\$89.28	8048060602	\$398.58	25
6"x10'	\$340.66	80120610SP	\$89.28	8048060602	\$429.94	28
8"x6'	\$267.12	80120806SP	\$98.87	6048080802	\$365.99	30
8"x8'	\$339.58	80120808SP	\$98.87	6048080802	\$438.45	32
8"x9'	\$376.35	80120809SP	\$98.87	6048080802	\$475.22	37
8"x10'	\$416.37	80120810SP	\$98.87	6048080802	\$515.24	40
8"x12'	\$495.32	80120812SP	\$98.87	6048080802	\$594.19	48
10"x6'	\$327.68	80121006SP	\$127.71	6048101002	\$455.39	39
10"x8'	\$416.37	80121008SP	\$127.71	6048101002	\$544.08	41
10"x9'	\$467.20	80121009SP	\$127.71	6048101002	\$594.91	46
10"x10'	\$513.70	80121010SP	\$127.71	6048101002	\$641.41	51
10"x12'	\$612.12	80121012SP	\$127.71	6048101002	\$739.83	65

- Note: 8" and 10" Tuscan cap and base sets listed above are Synthetic Injection Molded (SIM).
- Available un-boxed; call for pricing.
- Does not include installation kit. PermaFlashing not available.
- Not offered in split.

PermaLite Pallet Quantities

Size	Per Pallet
6"	49
8"	40
10"	24
12"	12



Capitals and Bases for Square PermaLite® Column List Pricing

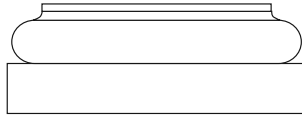

Tuscan Cap and Base for Square Columns

Column Size	Cap		Base		Set	
	Price	Stock #	Price	Stock #	Price	Stock #
6"	\$36.13	8048060622	\$53.13	8048060632	\$89.28	8048060602
8"	\$52.07	8048080822	\$79.71	8048080832	\$131.78	8048080802
8" SIM	Full Set Only		Full Set Only		\$98.87	6048080802
10"	\$69.08	8048101022	\$103.63	8048101032	\$172.71	8048101002
10" SIM	Full Set Only		Full Set Only		\$127.71	6048101002

Note: Neck Mould included with Cap and Base Set

SIM = Synthetic injection molded. All others are polyurethane

Recessed Panel Inserts and Dividers

Recessed Panel Insert Kit		
Kit Size	Stock #	List Price

8"	80480808PI	\$112.66
10"	80481010PI	\$146.68

- Each panel insert kit includes 8 pieces.
- 4 top and 4 bottom pieces

*Included with each boxed shaft.

Recessed Panel Divider Kit				
Kit Size	Height	Width	Stock #	List Price

8"	2 1/4"	4 7/8"	80480808PK	\$43.57
10"	3 7/8"	5 5/16"	80481010PK	\$61.64

- Each panel divider kit includes 4 pieces. One kit is needed to achieve a 2-panel column, and two kits for a 3-panel column.

*Sold separately

PermaLite® Beveled Cap & Base

Column Size	Stock #	List Price
6"	7060060602	\$95.28
8"	7060080802	\$107.99
10"	7060101002	\$133.40

- Note: requires A0262080 install kit below.

PermaLite® Colonial Square Poly Cap and Base Set*

Size	Stock #	List Price
6"	55297	\$78.34
8"	55301	\$110.11
10"	55305	\$143.99

*Low profile cap and base for railing applications

Installation Kit*

Stock #	Price
17040	\$17.96



Neck Mould

Column Size	Stock #	List Price
6"	8048060612	\$26.55
8"	8048080812	\$51.01
10"	8048101012	\$71.20

- See page 17 for Perma-Loc



Phone: (800) 264-4HBG
Fax: (334) 566-4629
www.hbgcolumns.com

SmartColumn® List Pricing

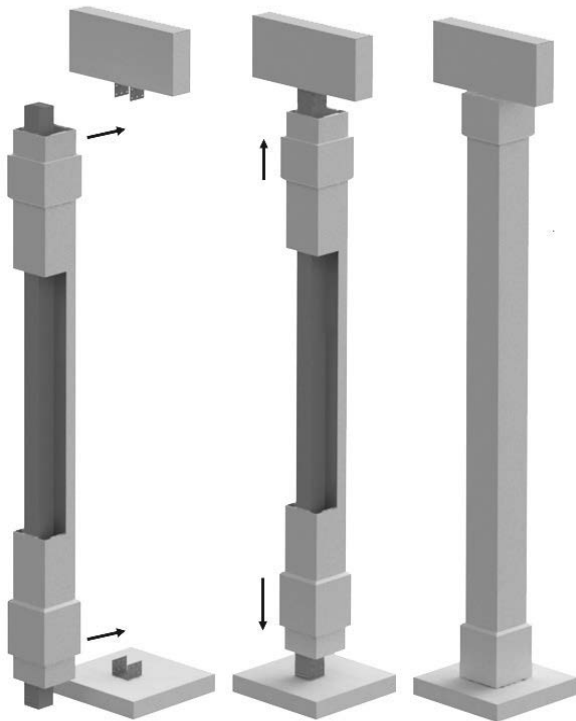

FEATURES:

- Easy installation! Installs 3.5 times faster than a typical site-built column.
- Limited Lifetime Warranty for peace of mind.
- Superior aesthetics compared to a site-built column.
- SmartColumn® = The Smart Choice

WHAT YOU NEED TO KNOW:

- Structural post and installation brackets are not included
- **Order by rough opening size. The column shaft itself is designed to be 12" shorter than the rough opening.**
- Capital and base attached to the column shaft conceal all hardware and post once installed.
- Available in square profiles only.

SmartColumn® List Pricing

Bottom Diameter X Height	Shaft Includes PVC Beveled Cap and Base 8" Price	Stock #
6"x8'	\$310.38	80190608SC
6"x9'	\$343.91	80190609SC
6"x10'	\$378.51	80190610SC
8"x8'	\$396.90	80190808SC
8"x9'	\$439.08	80190809SC
8"x10'	\$486.66	80190810SC
8"x12'	\$577.51	80190812SC
10"x8'	\$486.66	80191008SC
10"x9'	\$545.07	80191009SC
10"x10'	\$601.30	80191010SC
10"x12'	\$713.78	80191012SC



Phone: (800) 264-4HBG
 Fax: (334) 566-4629
www.hbgcolumns.com

ARCHITECTURAL WOOD COLUMNS (Custom)

All architectural wood columns are custom, made to order. Each wood column is formed of nominal 4" wide staves and interlocked together with a tongue and groove stave construction. The staves are glued with the highest quality Type 1, water-resistant glue and kept under pressure for a minimum of eighteen hours to ensure a proper adhesion. All architectural wood columns have a true architectural taper. The bottom one third of the shaft is straight and the top two thirds of the shaft is tapered. All diameters or widths are actual (not nominal) and all overall lengths are manufactured to your exact specified requirements.

It is recommended to use western red cedar or redwood for exterior applications. These species are naturally weather resistant and immune to decay and insect infestation. Pine or poplar may be used for interior use. We also offer a large selection of stain grade columns. Mahogany, maple, oak, and cherry are the most common species; however, other stain grade wood species, as well as exotic hardwoods, are also available. All columns used for exterior use have an interior asphaltum coating applied to the inside of the shaft. Columns that are to be painted are primed with two to three coats of an oil based primer after they are turned and then sanded in between each coat of primer to provide an excellent surface for your topcoat.

Columns may be plain or fluted with the flutes being either Doric or Ionic design. Since all architectural wood columns are custom, we can manufacture the shafts, caps, and bases to your exact specifications. Whether you are looking for an exact overall length or a specific diameter, we can manufacture exactly what you are looking for. A large selection of caps and bases are available to complement any design. Choose from Tuscan, Greek Doric, Roman Doric, or Attic to name a few. If you are looking for something more ornate, we have a complete line of decorative capitals to crown the top of your column while adding a stylish flourish. Columns may serve as a structural support or merely as a decorative accent. They are available in round or square.

Ordering or Quoting Requirements:

- 1.) Quantity required
- 2.) Design (Tuscan, Greek Doric, Roman Doric, or Attic)
- 3.) Plan type
- 4.) Bottom diameter/width and overall length
- 5.) Exterior or interior application
- 6.) Wood species
- 7.) Plain or fluted. If fluted, Ionic flute, or Doric flute?
- 8.) If columns are split for reassembly, specify shape and size of structural support
- 9.) Will columns match an existing column?

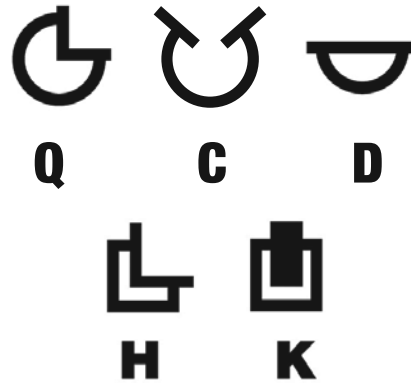

STOCK PAINT-GRADE WOOD COLUMNS

All paint-grade wood columns are round tapered, manufactured using a tongue and groove stave construction using select finger-jointed, softwood lumber. All sizes and dimensions are nominal. Column shafts may be round plain or fluted. All paint-grade wood columns are supplied with a standard Tuscan cap and base. If desired, a complete line of decorative capitals is also available. Columns may serve as a structural support or merely as a decorative accent.

Ordering or Quoting Requirements:

- 1.) Quantity required
- 2.) Plan type
- 3.) Bottom diameter and overall length
- 4.) Exterior or interior application
- 5.) Plain or fluted
- 6.) If columns are split for reassembly, specify shape and size of structural support



Phone: (800) 264-4HBG
Fax: (334) 566-4629
www.hbgcolumns.com

**STAIN-GRADE WOOD COLUMNS ARE ALSO AVAILABLE
CALL FOR QUOTE.**

ALL ITEMS (1-18) NEED TO BE FILLED OUT:

1. NEW MATCH Existing | 2. Quantity _____ | 3. Round Square
 4. Shaft Diameter/Width: 6" 8" 10" 12" Other: _____
 5. Net Height (including cap and base): _____ ft. _____ in.
 6. Tapered No-taper | 7. Plain Fluted—Specify*: Roman Ionic Greek Doric
 8. Interior Exterior | 9. Paint Grade Stain Grade (interior use only)
 10. Species—Interior: FJ Pine (paint grade) Poplar Alder Red Oak Maple Red Grandis
 Walnut Cherry Other: _____
 11. Species—Exterior: FJ Cedar (preferred) Red Grandis Other: _____
 12. Cap/Base Material: Wood (match shaft) Poly (8" to 14") Fiberglass (16" and up)
 13. Base Style: Tuscan Roman Doric Attic
 14. Cap Style: Tuscan Roman Doric Decorative (indicate below)
 Temple of Winds Roman Ionic Greek Ionic Erectheum Scamozzi Roman Corinthian



Roman Doric Ornamental

Empire

Greek Angular Ionic

Modern Composite



15. Plan Type:

- A AS B C D Q W N R
 E ES F H G K L O
-

Wall Width or Return: _____

*Flute Styles



16. Protection: Prime Asphalt Flashing (all required for exterior warranty)

17. Shipping to (Zip Code): _____

18. Special Instructions: _____

NOTE: Orders cannot be cancelled once production has begun.

Stock Round Tapered Wood Columns List Pricing

Bottom Diameter X Height	Plain Shaft		Standard Fluted Shaft		Cap & Base Set		Shaft & C/B		Split Shaft Plain		Split Shaft Fluted		Split Cap & Base Set		Wt. (lbs.)	Per Pallet
	Price	Stock #	Price	Stock #	Price	Stock #	Plain	Fluted	Price	Stock #	Price	Stock #	Price	Stock #		
6" x 8'	\$389.79	00011	\$494.16	00021	\$78.80	13000	\$468.59	\$572.96	\$490.97	00011S	\$643.26	00021S	\$107.56	13000S	18	36
6" x 10'	\$536.76	00031	\$664.56	00041	\$78.80	13000	\$615.56	\$743.37	\$672.02	00031S	\$863.72	00041S	\$107.56	13000S	22	36
8" x 8'	\$454.75	00051	\$552.74	00061	\$95.84	13030	\$550.60	\$648.58	\$593.21	00051S	\$673.08	00061S	\$126.73	13030S	38	36
8" x 10'	\$592.14	00071	\$675.21	00081	\$95.84	13030	\$687.98	\$771.06	\$739.12	00071S	\$878.63	00081S	\$126.73	13030S	46	36
8" x 12'	\$991.53	00091	\$1,120.39	00101	\$95.84	13030	\$1,087.37	\$1,216.24	\$1,240.74	00091S	\$1,459.07	00101S	\$126.73	13030S	54	36
10" x 8'	\$608.12	00111	\$699.71	00121	\$138.44	13060	\$746.56	\$838.15	\$761.48	00111S	\$911.65	00121S	\$182.11	13060S	49	24
10" x 10'	\$729.53	00131	\$847.75	00141	\$138.44	13060	\$867.97	\$986.19	\$911.65	00131S	\$1,043.71	00141S	\$182.11	13060S	59	24
10" x 12'	\$1,023.48	00151	\$1,245.00	00161	\$138.44	13060	\$1,161.92	\$1,383.44	\$1,278.02	00151S	\$1,367.48	00161S	\$182.11	13060S	68	24
12" x 8'	\$741.25	00171	\$918.04	00181	\$181.04	13090	\$922.29	\$1,099.08	\$928.69	00171S	\$1,197.08	00181S	\$237.49	13090S	63	16
12" x 10'	\$1,060.75	00191	\$1,198.14	00201	\$181.04	13090	\$1,241.80	\$1,379.18	\$1,325.94	00191S	\$1,560.25	00201S	\$237.49	13090S	69	16
12" x 12'	\$1,433.51	00211	\$1,635.87	00221	\$181.04	13090	\$1,614.56	\$1,816.91	\$1,793.49	00211S	\$1,918.10	00221S	\$237.49	13090S	85	16

*Primed – 20% upcharge

Additional sizes available, call for quote

Call for quote on all custom architectural wood products

For individual cap and base pricing, refer to pages 36 and 37.

Features

- 1 year warranty
- Stock pine columns are manufactured using paint-grade, finger-jointed pine.
- Wood columns can be painted any color.
- Round Wood columns are load bearing.

What You Need To Know

- A complete column consists of shaft, cap, and base.
- Cap and base fit on top and bottom of column insulating the column from the elements.
- Split columns are not load bearing.
- High quality exterior oil base primer and top coats must be used.
- Storage of columns must be in a dry, well ventilated area.
- For exterior applications: Coat inside of column shaft with a nonfibrous asphaltum-type roof coating. Application must reach a minimum 48" up the inside bottom of the column shaft.
- Wood columns require ventilation at the top and bottom. Please refer to installation instructions.
- Failure to adhere to installation instructions voids the warranty.
- Custom fluting available.
- When ordering a cap and base set, the standard model is shipped unless otherwise specified.



Phone: (800) 264-4HBG
 Fax: (334) 566-4629
 www.hbgcolumns.com

**12" x 14' Columns and Larger are Available.
 Call for Quote.**

Decorative Capitals for Round Wood Columns List Pricing

Features

- Molded from polyurethane resin or custom manufactured using plaster composite where noted
- Lightweight for easy installation
- Weather, rot, and insect proof

What You Need To Know

- All styles shown available for round.
- 8" - 12" Decorative Capitals for Round wood columns are load bearing.

Capital	8" Round		10" Round		12" Round	
	Price	Stock #	Price	Stock #	Price	Stock #
Roman Ionic	\$281.88	76911	\$378.85	76912	\$563.54	76913
Greek Ionic	\$307.29	76901	\$410.51	76902	\$504.96	76903
Temple of the Winds	\$453.65	76941	\$718.20	76942	\$909.44	76943
Roman Corinthian	\$431.34	76921	\$903.07	76922	\$1,387.54	76923
Scamozzi	\$217.95	76931	\$392.85	76932	\$833.16	76933

For Decorative Capital Larger than the 12" – Call for Quote.



Roman Ionic



Temple of the Winds



Scamozzi

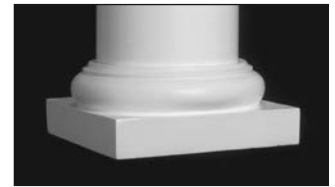

Tuscan Base



Greek Ionic



Roman Corinthian



Tuscan Cap

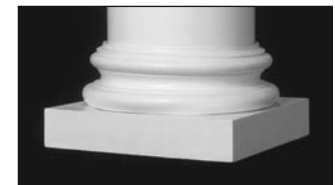

Attic Base

8" - 12"

Load Bearing Decorative Capitals for ROUND Wood Columns

Adding a load bearing decorative capital to a round wood column will lengthen or shorten the overall height of the column depending on the height of the capital. Subtract the "T" dimension (from the dimensions chart in the products brochure) and add the height of the decorative capital +/- 1/4" for overall column height.

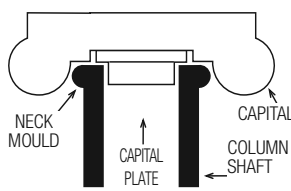

SECTION WITH LOAD BEARING DECORATIVE CAPITAL

6", 14" - 30"

Decorative Capitals for ROUND Wood Columns

Adding an decorative capital to a round or square wood column will lengthen or shorten the overall height of the column depending on the height of the capital. Subtract the "T" dimension (from dimension chart in the products brochure) and add the height of the decorative capital +/- 1/4" for overall column height.

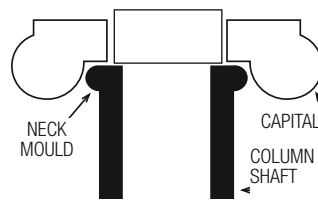

SECTION WITH DECORATIVE CAPITAL

Add 20% to all split caps and bases.



Phone: (800) 264-4HBG
 Fax: (334) 566-4629
www.hbgcolumns.com

Cap and Base Options for Round Wood Columns List Pricing

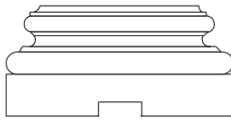

Attic Base

Poly Attic Base for Round Wood Columns

Column Size	Torus		Plinth		Set	
	Price	Stock #	Price	Stock #	Price	Stock #
8"	\$90.52	54092	\$62.83	14030	\$153.34	53110
10"	\$136.31	54112	\$109.69	14070	\$246.00	53120
12"	\$165.07	54132	\$136.31	14110	\$301.39	53130

Other sizes available, Call For Quote.

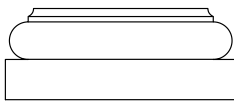

Standard Base

Standard Wood Cap & Base for Round Wood Columns

Column Size	Cap & Base Set	
	Price	Stock #
6"	\$167.20	12000
8"	\$199.15	12050
10"	\$288.61	12100
12"	\$413.22	12160

Other sizes available, Call For Quote.

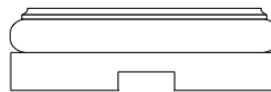

Standard Base

Standard Poly Caps & Bases for Round Wood Column

Column Size	Cap		Base	
	Price	Stock #	Price	Stock #
6"	\$25.55	13010	\$58.57	13020
8"	\$31.94	13040	\$71.35	13050
10"	\$46.85	13070	\$103.30	13080
12"	\$63.89	13100	\$112.88	13110

Cast Aluminum Plinths

Column Size	Plinth Size	List	
		Price	Stock #
6"	7-1/4"x7-1/4"x1-3/4"	\$59.63	01100
8"	9-1/4"x9-1/4"x1-3/4"	\$69.22	01110
10"	11-1/4"x11-1/4"x1-3/4"	\$85.19	01120
12"	13-1/4"x13-1/4"x1-3/4"	\$112.88	01130
12" o/s	16"x16"x3"	\$280.09	01140

**Add 20% to
all split caps
and bases.**

**Larger Caps and
Bases are Available
Call for Quote**



Phone: (800) 264-4HBG
Fax: (334) 566-4629
www.hbgcolumns.com

ALL SIZES OF WOOD CAPS & BASES. IF NOT LISTED HERE CALL FOR QUOTE.

Features

- The Colonial and Chamfered PermaPost® are manufactured from polyethylene
- The Square PermaPost® is manufactured from cellular PVC
- Galvanized pipe used in center of PermaPost®
- Weatherproof, rot, and insect proof
- Low maintenance
- Pre-finished white
- Installs using common carpentry tools

What You Need To Know

- PermaPost® includes top and bottom fasteners.
- Split PermaPost® is available and does not include galvanized pipe.
- Split PermaPost® is not load bearing.

Item	Size	List Price	Stock #	Split List Price	Weight (lbs)	Pallet Quantities	Load Bearing
Colonial	5" x 5" x 8'	\$259.60	PP5X8FF	\$16.00	17	50 or 100	1300
Colonial	5" x 5" x 9'	\$297.91	PP5X9FF	\$16.00	18	50 or 100	1300
Colonial	6" x 6" x 8'	\$405.37	PP6X8HD	\$16.00	32	36 or 72	5000
Colonial	6" x 6" x 9'	\$458.57	PP6X9HD	\$16.00	33	36 or 72	5000
Chamfered	6" x 6" x 8'	\$438.35	82001	\$16.00	20	28 or 56	5000
Square	5" x 5" x 8'	\$422.39	82010	\$16.00	20	45 or 90	5000
Square	5" x 5" x 9'	\$469.21	82011	\$16.00	25	45 or 90	5000
Square	5" x 5" x 10'	\$514.96	82012	\$16.00	30	45 or 90	5000

- Posts may be split for use as pilasters, but are not recommended for re-assembly. Split PermaPosts® have no pipe or foam.
- All sizes are nominal - **Nominal 5" = 4" 6" = 5"**

PermaPost® Injection Molded Fastening Kit*

Size	List Price	SKU#
5" Colonial	\$58.51	03469
6" Colonial	\$64.89	03470
Square	\$57.44	03471

Includes 4 brackets, 1 skirt, and all hardware necessary to attach post to surface structure. To prevent lateral movement only. Prefinished.

PermaPost® Injection Molded Skirt Only*

Size	List Price	Stock #	A (OD)	B (Height)
5" Colonial	\$42.55	03473	6-11/16"	1-1/16"
6" Colonial	\$42.55	03474	7-3/4"	1-9/16"
Chamfered	\$64.89	03475	7-3/4"	1-9/16"
Square	\$41.49	03476	6-11/16"	1-1/16"

* Pre-finished. Sold as each, not in pairs.

Porch-Loc®		
Size	List Price	SKU#
5" Colonial	\$111.38	03520
6" Colonial	\$112.44	03524
Square	\$115.63	03522

- Includes-2 Skirts, 2 brackets, all screws for one post.

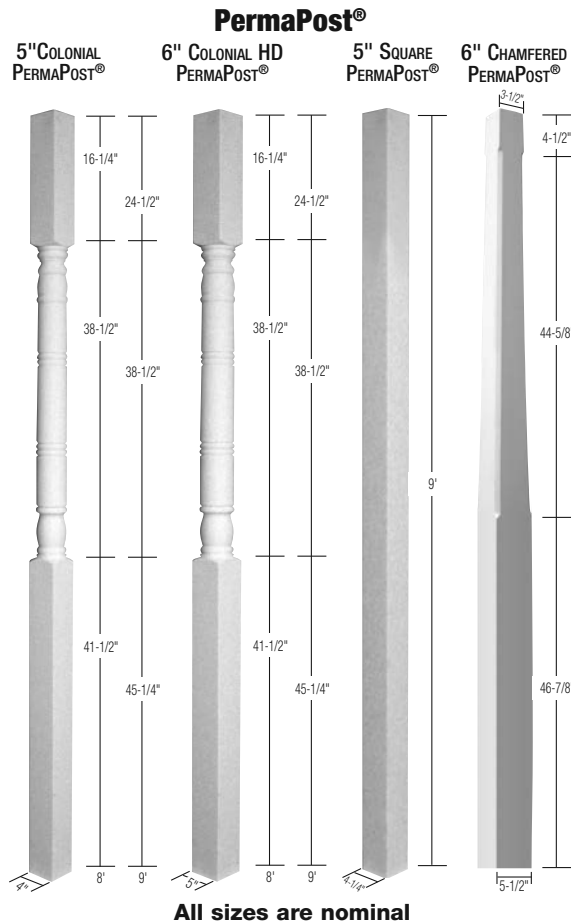

Top View of Fastener

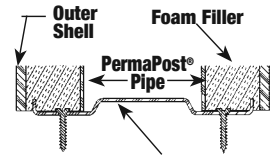
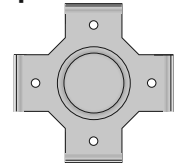

PermaPost® Fastener

Side View (cutaway)

Top View of Fastener

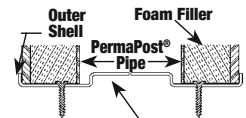
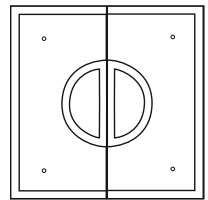

PermaPost® Fastener

Side View (cutaway)



Porch-Loc®



Injection Molded Skirt



Phone: (800) 264-4HBG
 Fax: (334) 566-4629
 www.hbgcolumns.com

PermaPost® Lamp Post List Pricing

Perma Lamp Post

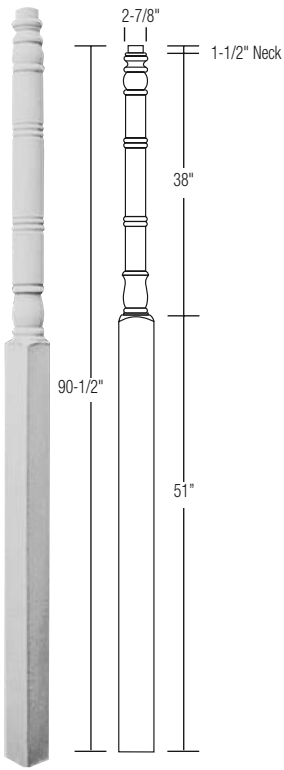

Chamfered Lamp Post

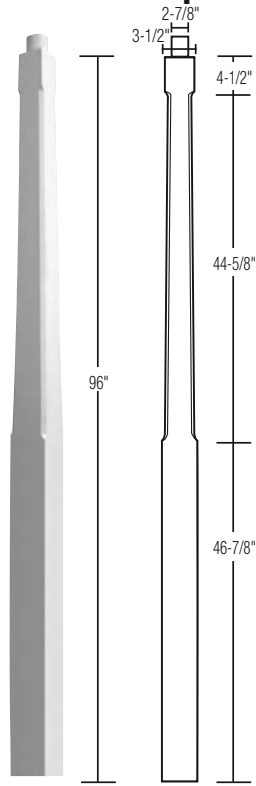

Size	List Price	Stock #	Pallet Weight	Quantities
Perma Lamp Post	\$276.63	WLP5X8	15 lbs.	28 or 49
Chamfered Lamp Post	\$438.35	82001	20 lbs.	28 or 56

Features

- The Perma and Chamfered Lamp Posts are manufactured from polyethylene.
- Galvanized pipe used in center of Perma Lamp Post. This makes the electrical hook-up a snap.
- Weatherproof, rot and insect proof
- Low maintenance
- Light fixture not included
- Pre-finished white



Phone: (800) 264-4HBG
Fax: (334) 566-4629
www.hbgcolumns.com

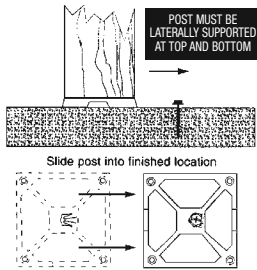

Aluminum Plinth

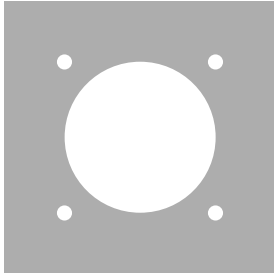

Top View



Side View

Size	List Price	Stock#
4"	\$10.60	01070
5"	\$11.66	01080
6"	\$12.72	01090

Nominal
4" = 3 1/4"
5" = 4 1/4"
6" = 5 1/4"

Wood Turned Posts List Pricing

Manufactured from kiln-dried Pine, fingerjointed and laminated. Quick Mount fasteners or aluminum plinths are required to maintain warranty.

Features

- Manufactured from paint-grade, kiln-dried pine. Finger-jointed and laminated
- Wood turned posts are load-bearing.
- 1 year warranty
- 4" is solid post
- 5" & 6" are hollow

What You Need To Know

- Storage of wood posts must be in a dry, well-ventilated area.
- Paint using paint manufacturer's recommendations.
- Must be mounted using an aluminum plinth or fastening system to avoid water damage.
- Failure to adhere to installation instructions voids the warranty.

STYLE # 100 (Primed)

Size	Price	8'		9'		10'	
		Price	Stock #	Price	Stock #	Price	Stock #
4"	\$161.87	02111		\$194.89	02141	-	-
5"	\$225.77	02121		\$301.39	02151	\$353.58	02181
6"	\$285.42	02131		\$380.20	02161	\$452.62	02191

Colonial Unprimed Wood Porch Post / STYLE # 100 (Unprimed)

Size	Price	8'		9'		10'	
		Price	Stock #	Price	Stock #	Price	Stock #
4"	\$142.70	02110		\$175.72	02140	-	-
5"	\$203.41	02120		\$270.51	02150	\$318.43	02180
6"	\$257.73	02130		\$351.45	02160	\$408.96	02190

Splitting charge for any wood post \$29.00

DIMENSIONS

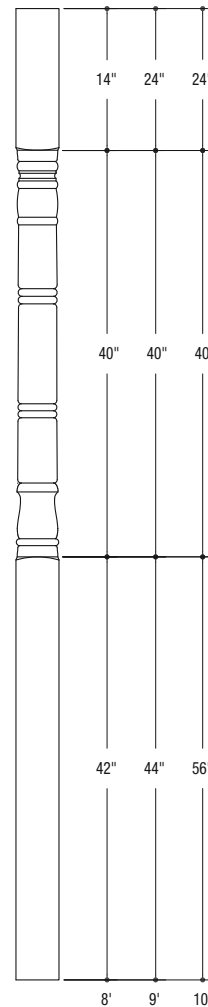

WOOD POST PALLET	
Size	Quantity
4"	52
5"	60
6"	40

NOTE: 42" bottom is standard on 8' #100 posts to accommodate most building codes.

No. 100

Nominal 4" = 3 1/4"; 5" = 4 1/4"; 6" = 5 1/4"



Phone: (800) 264-4HBG
Fax: (334) 566-4629
www.hbgcolumns.com

Three Ways To Order PermaRail Plus® Railing

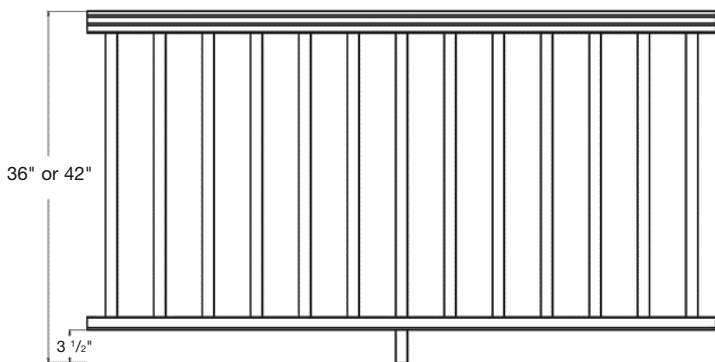

Each rail kit comes with installation hardware, support block and installation instructions. Overall rail height includes spacing under bottom rail.

*Design and build your own style.
See page 47 for more decorative rail panel
and pre-built sections.*

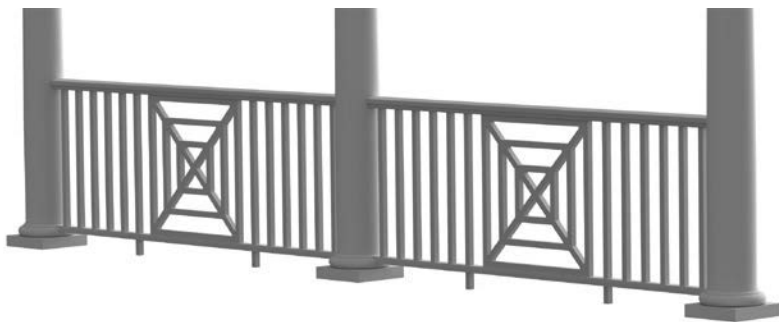

BUILDING CODE COMPLIANCE

PermaRail Plus® has been tested to the appropriate standards and found to be build code compliant (CCRR-0262) as follows:

Decorative Top Rail System			Standard Top Rail System		
	Level	Rake		Level	Rake
IRC	up to 12'	up to 8'	IRC	up to 8'	up to 8'
IBC	up to 10'	up to 8'	IBC	up to 8'	up to 8'

Review your application to ensure intended use complies with all applicable building codes.

1. Do-it-yourself Kit See Page 43

- Everything needed to assemble and install is included.
 - All standard level rail section components included in one box
 - Balusters and all installation hardware included
- Decorative top rail and Rake-Loc™ stair rail brackets sold separately
- **HOW TO ORDER:**
 - Choose Your Height: 36" 42"
 - Choose your Length: 6, 8, 10*, 12** 6, 8, 10**
 - Choose Optional Decorative Top Rail: Savannah, Newport, Belhaven
 - *When Kit is used with Decorative Top Rail systems. Standard Rail System has a maximum length of 8'.
 - Optional concealed adjustable stair rail brackets for 6' and 8' rail lengths.
 - Kit Includes:
 - Standard top and bottom rail
 - 1 ¼ balusters
 - Support block (s)
 - Aluminum stiffeners
 - Level-Loc™ rail assembly fasteners and installation hardware
 - Baluster Screw Kit

2. Individual Components See Page 43

- Build your Own Design
- For complete rail system you will need the following:
- Standard top and bottom rail (Note: Standard Rail System without Decorative Top Rail has a maximum length of 8')
- Optional Decorative Top Rail (if not using the Standard Top Rail as a stand alone system)
- Aluminum stiffeners (2)
 - Supplemental stiffener required for rail lengths over 8'
- 1¼ or 1½" Square Balusters or 1½" Turned Baluster – 30" or 36" long
- Support block(s)
- Baluster screw kit
- Level-Loc™ or Rake-Loc™ rail hardware kit

3. Pre-built Sections See Pages 45-46

- Shipped partially factory assembled in standard lengths
- Easy to install
- Everything needed to install included

■ HOW TO ORDER:

- Choose Your Height: 36" 42"
- Choose your Length: 6, 8, 10, * 12** 6, 8, 10**
- Choose Optional Decorative Top Rail: Savannah, Newport, Belhaven
- *When Kit is used with Decorative Top Rail systems. Standard Rail System has a maximum length of 8'.
- Choose Baluster
- Optional Concealed Adjustable Rake-Loc™ stair rail brackets for 6' and 8' rail lengths
- Onsite trimming and assembly completion required

NOTE: Prebuilt rail sections are made to order and cannot be cancelled or returned.



Phone: (800) 264-4HBG
Fax: (334) 566-4629
www.hbgcolumns.com

PermaRail Plus®

	Description	Size	SKU	Req. Purchase Qty.	List
KITS	36" PR Plus Standard 6' Kit	6'	04211	1	\$521.95
	36" PR Plus Standard 8' Kit	8'	04213	1	\$631.22
	36" PR Plus Standard 10' Kit	10'	04215	1	\$838.10
	36" PR Plus Standard 12' Kit	12'	04217	1	\$970.71
	42" PR Plus Standard 6' Kit	6'	04221	1	\$558.02
	42" PR Plus Standard 8' Kit	8'	04223	1	\$668.35
	42" PR Plus Standard 10' Kit	10'	04225	1	\$874.17
DECORATIVE TOP RAIL FOR KITS	PermaRail Plus Belhaven 6'	6'	04112	1	\$38.18
	PermaRail Plus Belhaven 8'	8'	04114	1	\$49.85
	PermaRail Plus Belhaven 10'	10'	04116	1	\$65.76
	PermaRail Plus Belhaven 12'	12'	04118	1	\$79.56
	PermaRail Plus Newport 6'	6'	04122	1	\$38.18
	PermaRail Plus Newport 8'	8'	04124	1	\$49.85
	PermaRail Plus Newport 10'	10'	04126	1	\$65.76
	PermaRail Plus Newport 12'	12'	04128	1	\$79.56
	PermaRail Plus Savannah 6'	6'	04132	1	\$38.18
	PermaRail Plus Savannah 8'	8'	04134	1	\$49.85
	PermaRail Plus Savannah 10'	10'	04136	1	\$65.76
	PermaRail Plus Savannah 12'	12'	04138	1	\$79.56
DECORATIVE TOP RAIL FOR COMPONENTS	Newport Top Rail - 6'	6'	04042	6	\$38.18
	Newport Top Rail - 8'	8'	04044	6	\$48.79
	Newport Top Rail - 10'	10'	04046	6	\$63.64
	Newport Top Rail - 12'	12'	04048	6	\$78.50
	Savannah Top Rail - 6'	6'	04052	6	\$38.18
	Savannah Top Rail - 8'	8'	04054	6	\$48.79
	Savannah Top Rail - 10'	10'	04056	6	\$63.64
	Savannah Top Rail - 12'	12'	04058	6	\$78.50
	Belhaven Top Rail - 6'	6'	04062	6	\$38.18
	Belhaven Top Rail - 8'	8'	04064	6	\$48.79
	Belhaven Top Rail - 10'	10'	04066	6	\$63.64
	Belhaven Top Rail - 12'	12'	04068	6	\$78.50
STANDARD TOP OR BOTTOM RAIL	Standard Rail - 6'	6'	04072	6	\$28.63
	Standard Rail - 8'	8'	04074	6	\$36.06
	Standard Rail - 10'	10'	04076	6	\$43.49
	Standard Rail - 12'	12'	04078	6	\$50.91
INSERTS	U-Channel Stiffener - 6'	6'	04001	6	\$49.85
	U-Channel Stiffener - 8'	8'	04002	6	\$65.76
	U-Channel Stiffener - 10'	10'	04003	6	\$81.68
	U-Channel Stiffener - 12'	12'	04004	6	\$102.90
	SUP I-Beam Stiffener - 10'	10'	04006	6	\$82.74
	SUP I-Beam Stiffener - 12'	12'	04005	6	\$106.08
BALUSTERS	1.25" Square Baluster - 36"	36"	04083	18	\$13.78
	1.25" Square Baluster - 30"	30"	04085	18	\$12.72
	1.50" Square Baluster - 36"	36"	04091	18	\$23.33
	1.50" Square Baluster - 30"	30"	04093	18	\$15.90
	1.5" Turned Baluster 30" PR Plus	30"	04079	18	\$23.33
	1.5" Turned Baluster 36" PR Plus	36"	04080	18	\$28.63
NEWELS	4.25" Newel Sleeve - 45"	45"	04095	1	\$92.29
	4.25" Newel Sleeve - 54"	54"	04096	1	\$103.96
	Newel-Loc 42" Newel Support	42"	04010	1	\$200.50
	Newel-Loc 36" Newel Support	36"	04009	1	\$159.12
	Newel Skirt	N/A	03476	1	\$40.23
	Chesterfield Newel Support Kit	37"	04015	1	\$180.34
	Chesterfield Newel	54"	04016	1	\$301.28
	Pyramid Newel Cap PR Plus	N/A	04099	1	\$19.09
HARDWARE ACCESSORIES	Rake-Loc Stair Rail Hardware Kit	N/A	04012	1	\$150.64
	Level-Loc Rail Hardware Kit	N/A	04013	1	\$95.47
	Upgraded Level-Loc Hardware Kit	N/A	04028	1	\$95.47
	Baluster Screw Kit - 6'	N/A	04017	1	\$15.90
	Baluster Screw Kit - 8'	N/A	04018	1	\$23.33
	Baluster Screw Kit - 10'	N/A	04019	1	\$28.63
	3.5" Crush Block	N/A	04087	1	\$2.11
	Touch Up Kit	N/A	04007	1	\$12.72
	Siroflex Adhesive	N/A	XA1034	1	\$12.72

- Pre-finished white
- Painting of the turned baluster, newel skirt, and pyramid cap are not recommended as paint adhesion may be an issue.

Code compliance testing for the 30" and 36" Turned Balusters is ongoing.



Phone: (800) 264-4HBG
Fax: (334) 566-4629
www.hbgcolumns.com

PermaRail Plus®

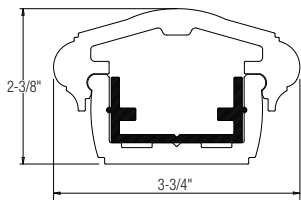

Savannah Top Rail with Aluminum Stiffener*

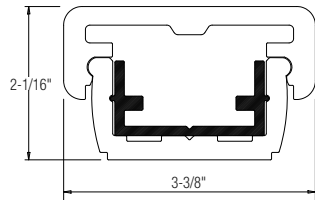

Belhaven Top Rail with Aluminum Stiffener*

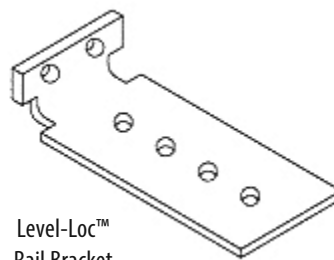

Level-Loc™ Rail Bracket

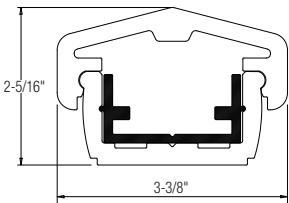

Newport Top Rail with Aluminum Stiffener*

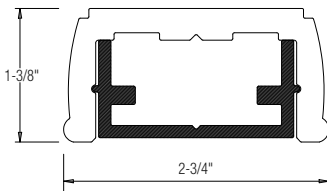

Standard Top Rail** and Universal Standard Bottom Rail with Aluminum Stiffener
**Maximum 8' Length

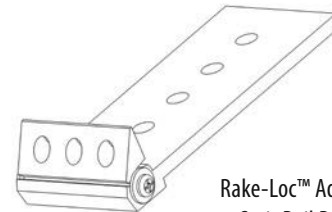

Rake-Loc™ Adjustable Stair Rail Bracket

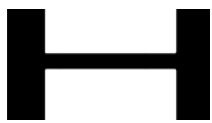

Supplemental Aluminum Stiffener for Savannah, Newport, and Bellhaven for Rail Lengths over 8'



Standard Aluminum Stiffener

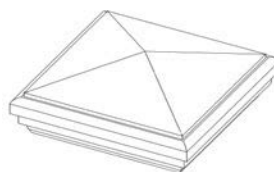

Newel Cap

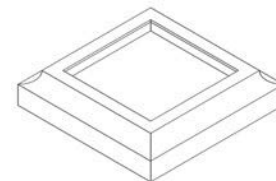

Newel Skirt

1-1/4" Square Baluster 30" and 36"



1-1/2" Square Baluster 30" and 36"



PermaRail Plus® Newel Sleeve 45" and 54"***

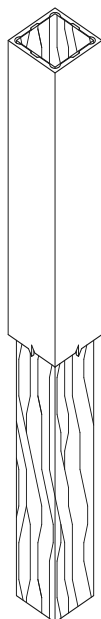

Newel-LoC™ Square Newel Post Mount Sleeve Support

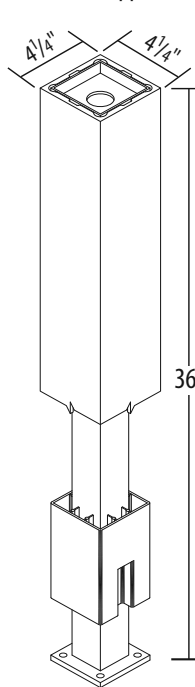
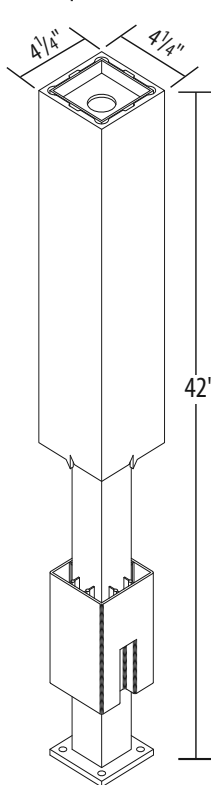

Chesterfield Newel Support

Chesterfield Newel

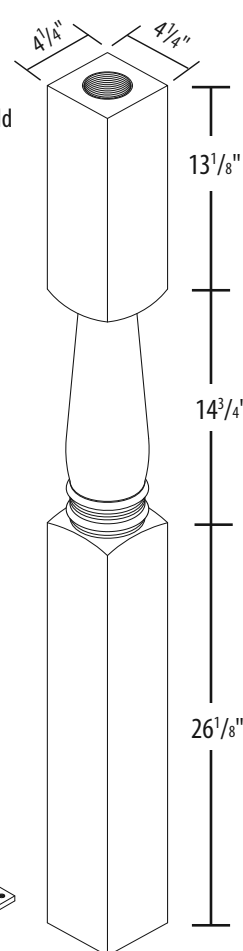

**Newel sleeves can be slid over an existing 4 x 4 or installed over the Newel-LoC™ Post Mount. The top rail, bottom rail, and balusters are pre-finished white. They are made from weather resistant cellular PVC.

*Sleeve Sold Separately



Phone: (800) 264-4HBG
Fax: (334) 566-4629
www.hbgcolumns.com

Pre-Built PermaRail Plus® Sections with Square Balusters

STANDARD LEVEL RAIL 36" HEIGHT

Length	1-1/4" Baluster		1-1/2" Baluster	
	Price	Stock #	Price	Stock #
4'	\$499.67	04141	\$538.92	04171
6'	\$709.73	04143	\$771.26	04173
8'	\$865.68	04145	\$946.31	04175

STANDARD LEVEL RAIL 42" HEIGHT

Length	1-1/4" Baluster		1-1/2" Baluster	
	Price	Stock #	Price	Stock #
4'	\$516.65	04151	\$564.39	04181
6'	\$733.07	04153	\$807.33	04183
8'	\$899.63	04155	\$994.05	04185

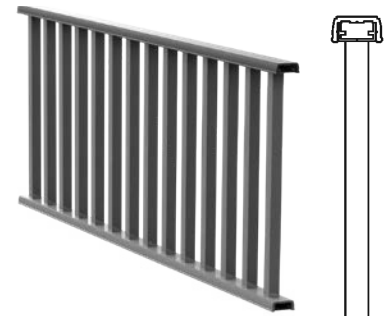

STANDARD RAKE RAIL 36" HEIGHT

Length	1-1/4" Baluster		1-1/2" Baluster	
	Price	Stock #	Price	Stock #
4'	\$628.04	04141R	\$667.29	04171R
6'	\$885.84	04143R	\$945.25	04173R
8'	\$1,069.37	04145R	\$1,146.82	04175R

STANDARD RAKE RAIL 42" HEIGHT

Length	1-1/4" Baluster		1-1/2" Baluster	
	Price	Stock #	Price	Stock #
4'	\$639.71	04151R	\$686.39	04181R
6'	\$903.87	04153R	\$978.14	04183R
8'	\$1,094.83	04155R	\$1,190.31	04185R



SAVANNAH LEVEL RAIL 36" HEIGHT

Length	1-1/4" Baluster		1-1/2" Baluster	
	Price	Stock #	Price	Stock #
4'	\$528.32	04141S	\$567.57	04171S
6'	\$747.92	04143S	\$800.97	04173S
8'	\$913.42	04145S	\$978.14	04175S
10'	\$1,234.87	04147S	\$1,321.87	04177S
12'	\$1,477.82	04149S	\$1,580.72	04179S

SAVANNAH LEVEL RAIL 42" HEIGHT

Length	1-1/4" Baluster		1-1/2" Baluster	
	Price	Stock #	Price	Stock #
4'	\$587.73	04151S	\$622.99	04181S
6'	\$844.46	04153S	\$929.33	04183S
8'	\$1,041.79	04155S	\$1,145.76	04185S
10'	\$1,397.19	04157S	\$1,537.23	04187S

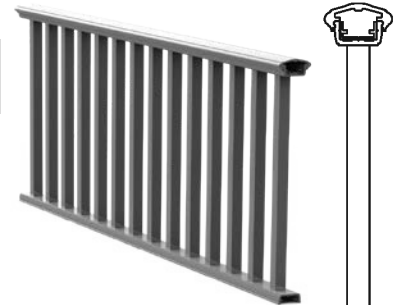

SAVANNAH RAKE RAIL 36" HEIGHT

Length	1-1/4" Baluster		1-1/2" Baluster	
	Price	Stock #	Price	Stock #
4'	\$652.44	04141SR	\$690.63	04171SR
6'	\$912.69	04143SR	\$983.44	04173SR
8'	\$1,194.56	04145SR	\$1,194.56	04175SR

SAVANNAH RAKE RAIL 42" HEIGHT

Length	1-1/4" Baluster		1-1/2" Baluster	
	Price	Stock #	Price	Stock #
4'	\$663.05	04151SR	\$709.73	04181SR
6'	\$943.13	04153SR	\$1,016.33	04183SR
8'	\$1,142.57	04155SR	\$1,321.87	04185SR



Rail height includes 3-1/2" spacing under bottom rail.

All pre-built rail sections are made to order and cannot be canceled or returned.

Rake rails are available in 4', 6', and 8' lengths. The rise and run of the stairs must be provided at the time of ordering.



Phone: (800) 264-4HBG
 Fax: (334) 566-4629
www.hbgcolumns.com

Pre-Built PermaRail Plus® Sections

NEWPORT LEVEL RAIL 36" HEIGHT

Length	1-1/4" Baluster		1-1/2" Baluster	
	Price	Stock #	Price	Stock #
4'	\$525.13	04141N	\$562.26	04171N
6'	\$748.98	04143N	\$808.39	04173N
8'	\$913.42	04145N	\$992.99	04175N
10'	\$1,234.87	04147N	\$1,332.47	04177N
12'	\$1,477.82	04149N	\$1,596.64	04179N

NEWPORT LEVEL RAIL 42" HEIGHT

Length	1-1/4" Baluster		1-1/2" Baluster	
	Price	Stock #	Price	Stock #
4'	\$534.02	04151N	\$629.10	04181N
6'	\$761.24	04153N	\$901.75	04183N
8'	\$936.56	04155N	\$1,116.05	04185N
10'	\$1,260.67	04157N	\$1,493.73	04187N

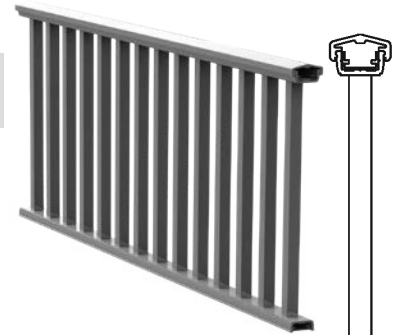

NEWPORT RAKE RAIL 36" HEIGHT

Length	1-1/4" Baluster		1-1/2" Baluster	
	Price	Stock #	Price	Stock #
4'	\$652.44	04141NR	\$709.73	04171NR
6'	\$922.97	04143NR	\$983.44	04173NR
8'	\$1,117.12	04145NR	\$1,194.56	04175NR

NEWPORT RAKE RAIL 42" HEIGHT

Length	1-1/4" Baluster		1-1/2" Baluster	
	Price	Stock #	Price	Stock #
4'	\$663.05	04151NR	\$709.73	04181NR
6'	\$943.13	04153NR	\$1,016.33	04183NR
8'	\$1,142.57	04155NR	\$1,235.93	04185NR



BELHAVEN LEVEL RAIL 36" HEIGHT

Length	1-1/4" Baluster		1-1/2" Baluster	
	Price	Stock #	Price	Stock #
4'	\$525.13	04141B	\$563.33	04171B
6'	\$747.92	04143B	\$808.39	04173B
8'	\$913.42	04145B	\$992.99	04175B
10'	\$1,234.87	04147B	\$1,333.54	04177B
12'	\$1,477.82	04149B	\$1,597.70	04179B

BELHAVEN LEVEL RAIL 42" HEIGHT

Length	1-1/4" Baluster		1-1/2" Baluster	
	Price	Stock #	Price	Stock #
4'	\$539.99	04151B	\$587.73	04181B
6'	\$770.20	04153B	\$843.40	04183B
8'	\$947.37	04155B	\$1,041.79	04185B
10'	\$1,275.19	04157B	\$1,397.19	04187B

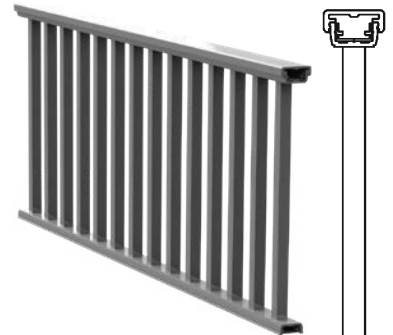

BELHAVEN RAKE RAIL 36" HEIGHT

Length	1-1/4" Baluster		1-1/2" Baluster	
	Price	Stock #	Price	Stock #
4'	\$652.44	04141BR	\$691.69	04171BR
6'	\$943.13	04143BR	\$983.44	04173BR
8'	\$1,142.57	04145BR	\$1,194.56	04175BR

BELHAVEN RAKE RAIL 42" HEIGHT

Length	1-1/4" Baluster		1-1/2" Baluster	
	Price	Stock #	Price	Stock #
4'	\$663.05	04151BR	\$709.73	04181BR
6'	\$983.44	04153BR	\$1,015.27	04183BR
8'	\$1,194.56	04155BR	\$1,235.93	04185BR



BUILDING CODE COMPLIANCE

PermaRail Plus® has been tested to the appropriate standards and found to be build code compliant (CCRR-0262) as follows:

Decorative Top Rail System

	Level	Rake
IRC	up to 12'	up to 8'
IBC	up to 10'	up to 8'

Standard Top Rail System

	Level	Rake
IRC	up to 8'	up to 8'
IBC	up to 8'	up to 8'

Review your application to ensure intended use complies with all applicable building codes.



Phone: (800) 264-4HBG
 Fax: (334) 566-4629
 www.hbgcolumns.com

Pre-Built PermaRail Plus® Turned Baluster Sections

PRE-BUILT LEVEL RAIL STANDARD TURNED BALUSTERS

SKU	Item Description	List Price
04271	4'x36" PB STD Lev Rail	\$547.41
04273	6'x36" PB STD Lev Rail	\$774.44
04275	8'x36" PB STD Lev Rail	\$974.96
04277	10'x36" PB STD Lev Rail	\$1,296.41
00429	12'x36" PB STD Lev Rail	\$1,549.96
04281	4'x42" PB STD Lev Rail	\$561.21
04283	6'x42" PB STD Lev Rail	\$814.76
04285	8'x42" PB STD Lev Rail	\$1,002.54
04287	10'x42" PB STD Lev Rail	\$1,349.45

PRE-BUILT LEVEL RAIL SAVANNAH TURNED BALUSTERS

SKU	Item Description	List Price
04271S	4'x36" PB SAV Lev Rail	\$601.51
04273S	6'x36" PB SAV Lev Rail	\$823.24
04275S	8'x36" PB SAV Lev Rail	\$1,041.79
04277S	10'x36" PB SAV Lev Rail	\$1,402.49
04279S	12'x36" PB SAV Lev Rail	\$1,669.84
04281S	4'x42" PB SAV Lev Rail	\$628.04
04283S	6'x42" PB SAV Lev Rail	\$863.56
04285S	8'x42" PB SAV Lev Rail	\$1,055.58
04287S	10'x42" PB SAV Lev Rail	\$1,430.08

PRE-BUILT LEVEL RAIL NEWPORT TURNED BALUSTERS

SKU	Item Description	List Price
04271N	4'x36" PB NEW Lev Rail	\$601.51
04273N	6'x36" PB NEW Lev Rail	\$823.24
04275N	8'x36" PB NEW Lev Rail	\$1,041.79
04277N	10'x36" PB NEW Lev Rail	\$1,402.49
04279N	12'x36" PB NEW Lev Rail	\$1,669.84
04281N	4'x42" PB NEW Lev Rail	\$628.04
04283N	6'x42" PB NEW Lev Rail	\$863.56
04285N	8'x42" PB NEW Lev Rail	\$1,055.58
04287N	10'x42" PB NEW Lev Rail	\$1,430.08

PRE-BUILT LEVEL RAIL BELHAVEN TURNED BALUSTERS

SKU	Item Description	List Price
04271B	4'x36" PB BEL Lev Rail	\$601.51
04273B	6'x36" PB BEL Lev Rail	\$823.24
04275B	8'x36" PB BEL Lev Rail	\$1,041.79
04277B	10'x36" PB BEL Lev Rail	\$1,402.49
04279B	12'x36" PB BEL Lev Rail	\$1,669.84
04281B	4'x42" PB BEL Lev Rail	\$628.04
04283B	6'x42" PB BEL Lev Rail	\$863.56
04285B	8'x42" PB BEL Lev Rail	\$1,055.58
04287B	10'x42" PB BEL Lev Rail	\$1,430.08

PRE-BUILT RAKE RAIL STANDARD TURNED BALUSTERS

SKU	Item Description	List Price
04271R	4'x36" PB STD RAKE Rail	\$694.88
04273R	6'x36" PB STD RAKE Rail	\$968.59
04275R	8'x36" PB STD RAKE Rail	\$1,173.34
04281R	4'x42" PB STD RAKE Rail	\$707.60
04283R	6'x42" PB STD RAKE Rail	\$885.94
04285R	8'x42" PB STD RAKE Rail	\$1,189.25

PRE-BUILT RAKE RAIL SAVANNAH TURNED BALUSTERS

SKU	Item Description	List Price
04271SR	4'x36" PB SAV RAKE Rail	\$721.40
04273SR	6'x36" PB SAV RAKE Rail	\$1,009.96
04275SR	8'x36" PB SAV RAKE Rail	\$1,215.77
04281SR	4'x42" PB SAV RAKE Rail	\$735.19
04283SR	6'x42" PB SAV RAKE Rail	\$1,041.79
04285SR	8'x42" PB SAV RAKE Rail	\$1,242.30

PRE-BUILT RAKE RAIL NEWPORT TURNED BALUSTERS

SKU	Item Description	List Price
04271NR	4'x36" PB NEW RAKE Rail	\$721.40
04273NR	6'x36" PB NEW RAKE Rail	\$1,009.96
04275NR	8'x36" PB NEW RAKE Rail	\$1,215.77
04281NR	4'x42" PB NEW RAKE Rail	\$40.23
04283NR	6'x42" PB NEW RAKE Rail	\$1,041.79
04285NR	8'x42" PB NEW RAKE Rail	\$1,242.30

PRE-BUILT RAKE RAIL BELHAVEN TURNED BALUSTERS

SKU	Item Description	List Price
04271BR	4'x36" PB BEL RAKE Rail	\$721.40
04273BR	6'x36" PB BEL RAKE Rail	\$1,009.96
04275BR	8'x36" PB BEL RAKE Rail	\$1,215.77
04281BR	4'x42" PB BEL RAKE Rail	\$735.19
04283BR	6'x42" PB BEL RAKE Rail	\$1,041.79
04285BR	8'x42" PB BEL RAKE Rail	\$1,242.30

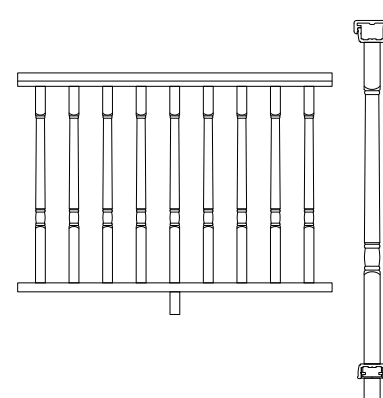
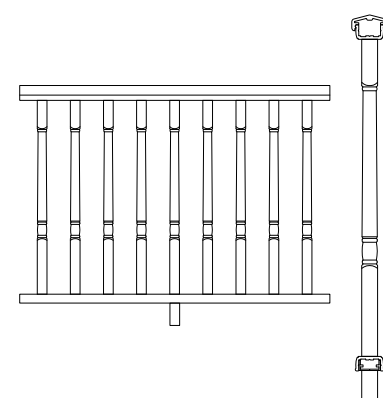
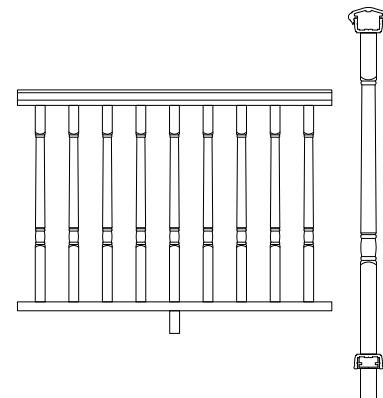
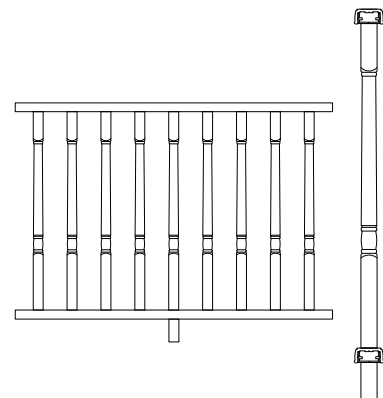

Phone: (800) 264-4HBG
 Fax: (334) 566-4629
www.hbgcolumns.com

6" Balustrade System

Features

- 25 year limited warranty
- Made of high-density polyurethane
- Weather, rot, and insect proof
- Low maintenance
- Easy installation

What you need to know

- Balustrade systems are factory primed.
- Paint using paint manufacturer's recommendations.
- Use body filler to repair or fill holes.
- The space between the bottom rail and substrate should not be less than 2".
- One rail hardware kit is required per each rail section.
- When ordering a ball top, also order a flat cap for proper installation.

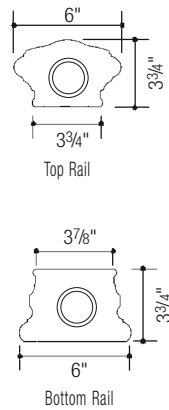
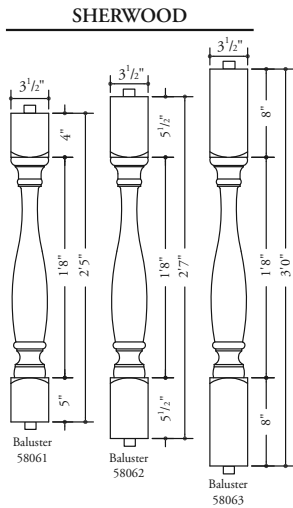

	Item	Length	Stock #	Carton Qty	Wt. (lbs.)	List Price Each
	Top Rail	8'	57021	1	15	\$681.57
	Top Rail	10'	57022	1	15	\$763.93
	Top Rail	12'	57023	1	19	\$846.28
	Bottom Rail	8'	57024	1	19	\$681.57
	Bottom Rail	10'	57025	1	22	\$763.93
	Bottom Rail	12'	57026	1	23	\$846.28
Square	3" Square Baluster	3" x 26 1/2"	58029	1	3	\$252.47
	3" Square Extended Baluster	3" x 32 7/8"	58030	1	4	\$267.64
Shannon	3" Baluster	3" x 20"	58031	1	2	\$229.71
	3" Extended Baluster	3" x 33-5/8"	58032	1	4	\$288.23
	3" Baluster	3" x 28"	58036	1	3	\$248.13
Shelby	3-3/8" Baluster	3-3/8" x 24"	58033	1	3	\$227.55
	3-3/8" Baluster	3-3/8" x 26-1/2"	58034	1	3	\$234.05
	3-3/8" Extended Baluster	3-3/8" x 32-7/8"	58035	1	4	\$257.89
Saffron	3-1/2" Baluster	3-1/2" x 32-1/2"	58037	1	3	\$274.14
	3-1/2" Extended Baluster	3-1/2" x 38"	58038	1	4	\$316.40
Sherwood	3-1/2" Baluster	3-1/2" x 29"	58061	1	3	\$255.72
	3-1/2" Baluster	3-1/2" x 31"	58062	1	3	\$282.81
	3-1/2" Extended Baluster	3-1/2" x 36"	58063	1	4	\$316.40
	Pyramid Cap	3"	57085	1	2	\$139.77
	Flat Cap	1-5/8"	57086	1	2	\$117.02
	Ball Top	8-1/4"	57087	1	2	\$185.28
	Five Sided Pyramid Cap	3"	57083	1	4	\$154.94
	Newel	48"	57088	1	29	\$517.95
	Five Sided Angel Newel	48"	57084	1	43	\$755.26
	Panel/Corner Newel	48"	57089	1	31	\$675.07
	Support Block	3"	58013	1	1	\$56.34
	Rail Kit	N/A	58001	1	1	\$71.51
	Newel Kit	N/A	58003	1	6	\$183.12
	Rail Kit for Five Sided Newel	N/A	58002	1	1	\$111.60

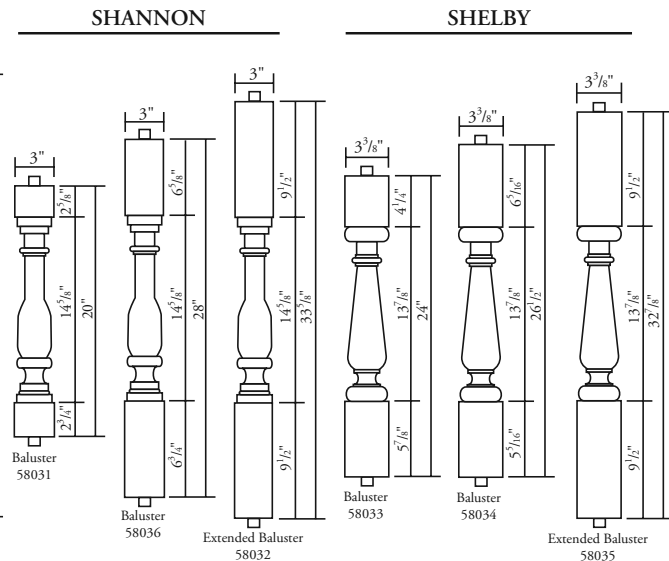
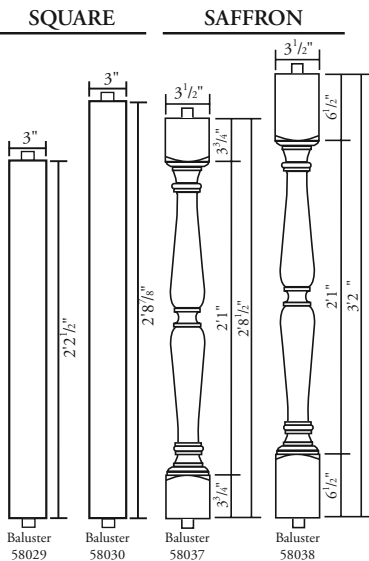

SKU	M	Maximum Spacing	O/C
58031	3/4"	2-1/4"	5-1/4"
58032	3/4"	2-1/4"	5-1/4"
58036	3/4"	2-1/4"	5-1/4"
58033	1"	2-1/8"	5-1/2"
58034	1"	2-1/8"	5-1/2"
58035	1"	2-1/8"	5-1/2"
58037	1"	2"	5-1/2"
58038	1"	2"	5-1/2"
58029	0"	4"	7"
58030	0"	4"	7"
58061	1-1/16"	1-3/4"	5-1/4"
58062	1-1/16"	1-3/4"	5-1/4"
58063	1-1/16"	1-3/4"	5-1/4"



Phone: (800) 264-4HBG
 Fax: (334) 566-4629
 www.hbgcolumns.com

7" Balustrade System

Features

- 25 year limited warranty
- Made of high-density polyurethane
- Weather, rot, and insect proof
- Low maintenance
- Easy installation

What you need to know

- Balustrade systems are factory primed.
- Paint using paint manufacturer's recommendations.
- Use body filler to repair or fill holes
- The space between the bottom rail and substrate should not be less than 2".
- One rail hardware kit is required per each rail section.
- When ordering a ball top also order a flat cap for proper installation.

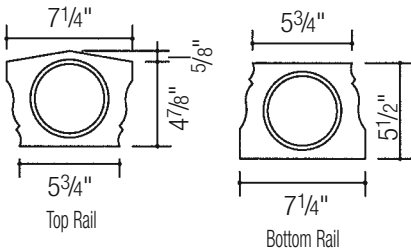

	Item	Length	Stock #	Carton Qty	Wt. (lbs.)	List Price Each
	Top Rail	8'	57031	1	36	\$763.93
	Top Rail	10'	57032	1	48	\$872.29
	Top Rail	12'	57033	1	55	\$983.90
	Bottom Rail	8'	57034	1	36	\$763.93
	Bottom Rail	10'	57035	1	48	\$872.29
	Bottom Rail	12'	57036	1	55	\$983.90
Calvert	5-1/4" Baluster	5-1/4" x 23"	58041	1	7	\$214.54
	5-1/4" Baluster	5-1/4" x 29"	58045	1	7	\$338.07
	5-1/4" Extended Baluster	5-1/4" x 35"	58042	1	8	\$357.58
Carrington	5-1/4" Baluster	5-1/4" x 26"	58043	1	7	\$232.96
	5-1/4" Baluster	5-1/4" x 34"	58046	1	9	\$357.58
	5-1/4" Extended Baluster	5-1/4" x 40"	58044	1	9	\$371.66
Clement	5-1/4" Baluster	5-1/4" x 29"	58091	1	7	\$321.82
	5-1/4" Baluster	5-1/4" x 31"	58092	1	7	\$347.82
	5-1/4" Extended Baluster	5-1/4" x 36"	58093	1	9	\$359.74
	Pyramid Cap	3"	57085	1	2	\$139.77
	Flat Cap	1-5/8"	57086	1	2	\$117.02
	Ball Top	8-1/4"	57087	1	2	\$185.28
	Five Sided Pyramid Cap	3"	57083	1	4	\$154.94
	Newel	48"	57088	1	29	\$517.95
	Five Sided Angel Newel	48"	57084	1	43	\$755.26
	Panel/Corner Newel	48"	57089	1	31	\$675.07
	Support Block	3"	58012	1	1	\$60.67
	Rail Kit	N/A	58001	1	1	\$71.51
	Newel Kit	N/A	58003	1	6	\$183.12
	Rail Kit for Five Sided Newel	N/A	58002	1	1	\$111.60

CLEMENT

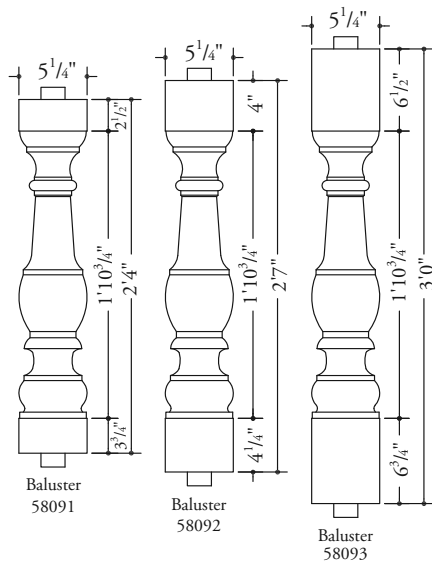

CALVERT

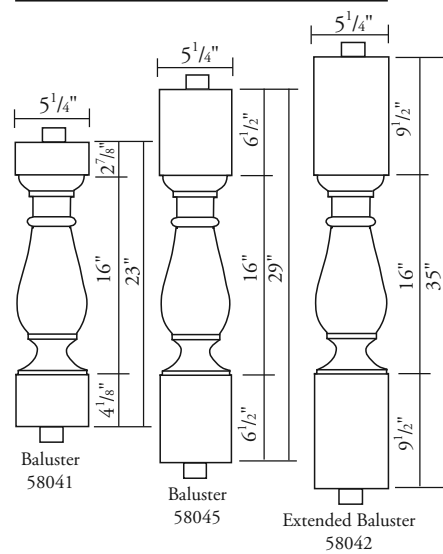

CARRINGTON

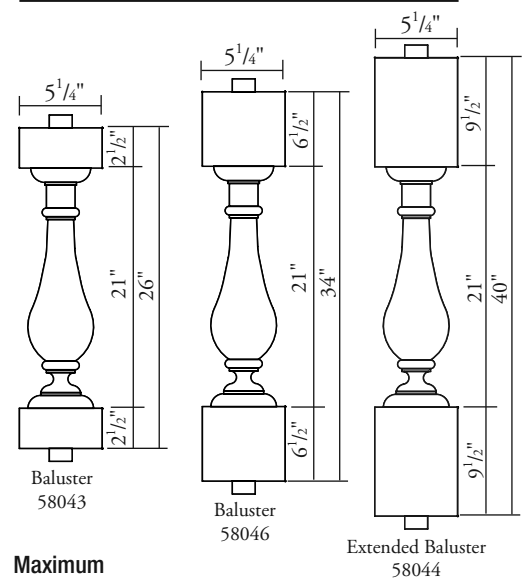

SKU	M	Maximum Spacing	O/C
58041	1-1/4"	1-1/4"	6-1/2"
58042	1-1/4"	1-1/4"	6-1/2"
58045	1-1/4"	1-1/4"	6-1/2"
58043	1-1/2"	3/4"	6"
58044	1-1/2"	3/4"	6"
58046	1-1/2"	3/4"	6"
58091	1-5/16"	1-3/8"	6-5/8"
58092	1-5/16"	1-3/8"	6-5/8"
58093	1-5/16"	1-3/8"	6-5/8"



Phone: (800) 264-4HBG
 Fax: (334) 566-4629
 www.hbgcolumns.com

12" Balustrade System

Features

- 25 year limited warranty
- Made of high-density polyurethane
- Weather, rot, and insect proof
- Low maintenance
- Easy installation

What you need to know

- Balustrade systems are factory primed.
- Paint using paint manufacturer's recommendations.
- Use body filler to repair or fill holes.
- The space between the bottom rail and substrate should not be less than 2".
- One rail hardware kit is required per each rail section.
- When ordering a ball top also order a flat cap for proper installation.

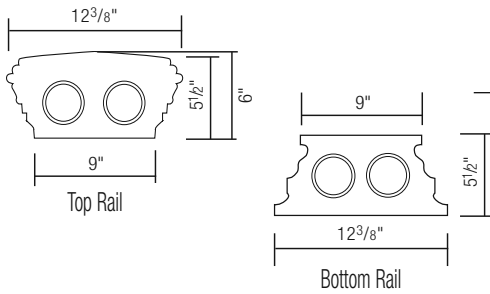

	Item	Length	Stock #	Carton Qty	Wt. (lbs.)	List Price Each
	Top Rail	8'	57061	1	56	\$1,111.76
	Top Rail	10'	57062	1	70	\$1,264.55
	Top Rail	12'	57063	1	84	\$1,360.99
	Bottom Rail	8'	57064	1	57	\$1,111.76
	Bottom Rail	10'	57065	1	71	\$1,264.55
	Bottom Rail	12'	57066	1	85	\$1,360.99
Mandeville	7" Baluster	7" x 26"	58051	1	10	\$367.33
	7" Baluster	7" x 30"	58052	1	11	\$456.18
	7" Extended Baluster	7" x 38"	58053	1	16	\$488.69
Manasses	7-1/4" Baluster	7-1/4" x 28"	58054	1	11	\$439.93
	7-1/4" Baluster	7-1/4" x 34"	58055	1	12	\$548.29
	7-1/4" Extended Baluster	7-1/4" x 40"	58056	1	16	\$563.46
	Classic Cap	4-7/8"	57097	1	4	\$193.96
	Pyramid Cap	3"	57091	1	5	\$185.28
	Flat Cap	2"	57092	1	4	\$201.54
	Ball Top	7"	63058	1	2	\$343.60
	Ball Top	10"	57096	1	7	\$309.90
	Ball Top	12"	57093	1	10	\$391.17
	Newel	48"	57094	1	72	\$1,112.84
	Panel/Corner Newel	48"	57095	1	72	\$1,186.53
	Support Block	3-1/2"	58014	1	2	\$83.42
	Rail Kit	N/A	58001	1	1	\$71.51
	Newel Kit	N/A	58007	1	6	\$213.45

SKU	M	Maximum Spacing	O/C
58051	1-7/8"	3/16"	7-1/8"
58052	1-7/8"	3/16"	7-1/8"
58053	1-7/8"	3/16"	7-1/8"
58054	2-3/8"	0"	7-1/4"
58055	2-3/8"	0"	7-1/4"
58056	2-3/8"	0"	7-1/4"

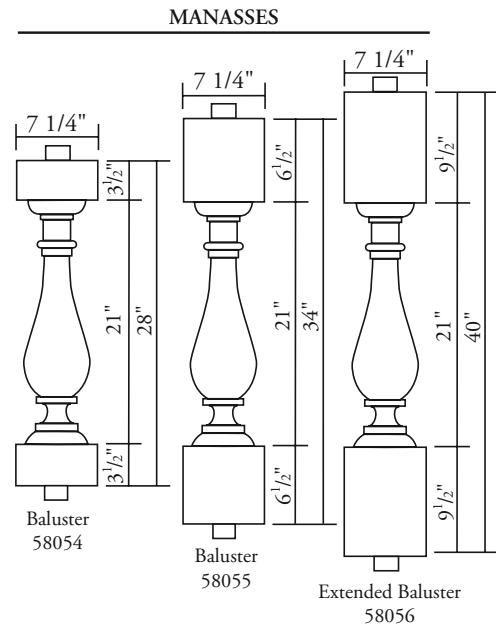
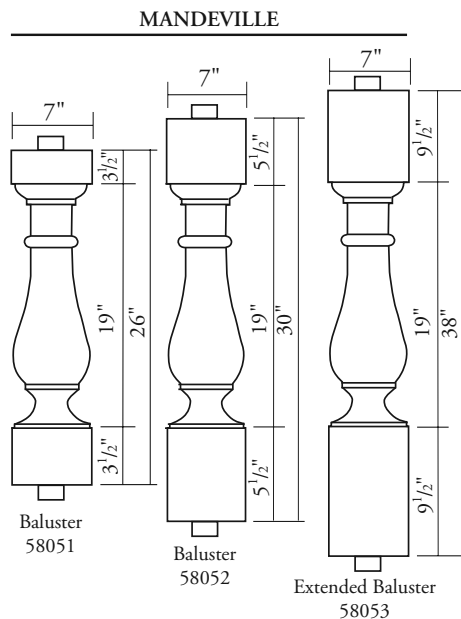

Phone: (800) 264-4HBG
 Fax: (334) 566-4629
 www.hbgcolumns.com

6" Curved Balustrade System

Stock #	Rail Length	Rail Radius	Description	List Price	Stock Number	Modified Radius	Modified List Price
58230	10'	60"	Top Rail	\$1,463.93	58230m	61"-66"	\$2,926.79
58232	10'	72"	Top Rail	\$1,463.93	58232m	67"-78"	\$2,926.79
58234	10'	84"	Top Rail	\$1,463.93	58234m	79"-90"	\$2,926.79
58236	10'	96"	Top Rail	\$1,463.93	58236m	91"-102"	\$2,926.79
58238	10'	108"	Top Rail	\$1,463.93	58238m	103" or greater	\$2,926.79
58240	10'	60"	Bottom Rail	\$1,463.93	58240m	61"-66"	\$2,926.79
58242	10'	72"	Bottom Rail	\$1,463.93	58242m	67"-78"	\$2,926.79
58244	10'	84"	Bottom Rail	\$1,463.93	58244m	79"-90"	\$2,926.79
58246	10'	96"	Bottom Rail	\$1,463.93	58246m	91"-102"	\$2,926.79
58248	10'	108"	Bottom Rail	\$1,463.93	58248m	"103""- or greater (except 108")	\$2,926.79

CALL FOR ADDITIONAL RADIUS

Top and bottom rail only, must order balusters separately.

7" Curved Balustrade System

Stock #	Rail Length	Rail Radius	Description	List Price	Stock Number	Modified Radius	Modified List Price
58200	10'	60"	Top Rail	\$1,610.22	58200m	61"-66"	\$3,215.03
58202	10'	72"	Top Rail	\$1,610.22	58202m	67"-78"	\$3,215.03
58204	10'	84"	Top Rail	\$1,610.22	58204m	79"-90"	\$3,215.03
58206	10'	96"	Top Rail	\$1,610.22	58206m	91"-102"	\$3,215.03
58208	10'	108"	Top Rail	\$1,610.22	58208m	103" or greater	\$3,215.03
58210	10'	60"	Bottom Rail	\$1,610.22	58210m	61"-66"	\$3,215.03
58212	10'	72"	Bottom Rail	\$1,610.22	58212m	67"-78"	\$3,215.03
58214	10'	84"	Bottom Rail	\$1,610.22	58214m	79"-90"	\$3,215.03
58216	10'	96"	Bottom Rail	\$1,610.22	58216m	91"-102"	\$3,215.03
58218	10'	108"	Bottom Rail	\$1,610.22	58218m	"103""- or greater (except 108")	\$3,215.03

CALL FOR ADDITIONAL RADIUS

Top and bottom rail only, must order balusters separately.



Phone: (800) 264-4HBG
 Fax: (334) 566-4629
www.hbgcolumns.com

Outdoor Living List Pricing

MOR-SHADE® FOR SERENITY® FIBERGLASS PERGOLA SERIES

MOR-SHADE® PURLIN

Stock #	Style	Overhead	List Price
MSP1212FS	Freestanding	12'x12'	\$1,496.39
MSP1414FS	Freestanding	14'x14'	\$1,684.21
MSP1616FS	Freestanding	16'x16'	\$2,057.80

- Depending on style/size may have more than one panel.

MOR-SHADE® CANOPY

Stock #	Style	Canopy Size	List Price
MSC1212FS	Freestanding	12'x12'	\$6,173.41
MSC1414FS	Freestanding	14'x14'	\$8,231.22
MSC1616FS	Freestanding	16'x16'	\$11,037.23

- Depending on style/size may have more than one panel.

FIBERGLASS PRIVACY SCREENS

Stock #	Item	List Price
910112	12' Privacy Screen	\$7,481.99

FIBERGLASS ENTRY ARBOR

Stock #	Item	List Price
910002	12'x3' Round Entry Arbor	\$4,674.95
910003	12'x3' Square Entry Arbor	\$4,674.95

FIBERGLASS TRELLISES (EYEBROWS)

Stock #	Item	List Price
911011	11' Trellis	\$2,506.72
911018	18' Trellis	\$2,992.79
911020	20' Trellis	\$3,740.99

FIBERGLASS SEMI CUSTOM OPTIONS

(See catalog for color and rafter options)

Stock #	Item	List Price
Paint	Special Paint Color	\$1,261.09
Tail	Special Rafter Tail	\$211.55
ADR FB 16	Fan Bracket	\$351.90

**CUSTOM PERGOLAS,
ARBORS, AND TRELLISES
AVAILABLE.
CALL FOR QUOTE!**



**Phone: (800) 264-4HBG
Fax: (334) 566-4629
www.hbgcolumns.com**

Outdoor Living List Pricing

FIBERGLASS PERGOLA FEATURES

- Limited Lifetime Warranty
- Wind Load Rated
- Assembly hardware included
- Will Not Rot/Insect Proof
- Low Maintenance
- Lightweight/ Easy Handling and Installation



Napa Tails

SERENITY® FIBERGLASS PERGOLA SERIES

Stock #	Overhead	Column	Style	List Price
920101	12'x12'	Pergola Kit Sq PermaLite® NT	Free Standing	\$12,605.87
920111	14'x14'	Pergola Kit Sq PermaLite®NT	Free Standing	\$14,708.05
920121	16'x16'	Pergola Kit Sq PermaLite® NT	Free Standing	\$16,811.27
900001		Rd Wind Load/ Deck Plate 8" Columns	*	\$153.76
900003		Rd Wind Load/ Deck Plate 10" Columns	*	\$216.71
900002		Sq Wind Load/ Deck Plate 8" Columns	*	\$153.76
900004		Sq Wind Load/ Deck Plate 10" Columns	*	\$216.71
900031		Rd Wind Load Plate 8" Columns	*	\$236.32
900033		Rd Wind Load Plate 10" Columns	*	\$293.08
900032		Sq Wind Load Plate 8" Columns	*	\$236.32
900034		Sq Wind Load Plate 10" Columns	*	\$293.08

NOTE: Serenity® fiberglass pergolas are prefinished with white Benjamin Moore Command® Coating, PermaLite® columns, Napa rafter tails, and are single support rafter with header style.
*Each Plate

TRANQUILITY® PREDESIGNED ATTACHED FIBERGLASS PERGOLA SERIES

PERMACAST® ROUND TAPERED COLUMN

Stock #	Overhead	Column Size	Column Center	List Price
980201	12'x10'	10"x8'	8'x8'	\$11,410.81
980205	12'x12'	10"x8'	8'x10'	\$12,157.98
980209	12'x14'	10"x8'	8'x12'	\$13,281.83
980213	12'x16'	10"x8'	8'x14'	\$14,215.79
980217	12'x18'	10"x8'	8'x16'	\$14,965.02
980221	12'x20'	10"x8'	8'x18'	\$16,085.77
980225	14'x10'	10"x8'	10'x8'	\$12,157.98
980229	14'x12'	10"x8'	10'x10'	\$13,281.83
980233	14'x14'	10"x8'	10'x12'	\$14,591.44
980237	14'x16'	10"x8'	10'x14'	\$15,685.36
980241	14'x20'	10"x8'	10'x18'	\$16,647.18
980245	16'x10'	10"x8'	12'x8'	\$13,654.38
980249	16'x12'	10"x8'	12'x10'	\$14,591.44
980253	16'x14'	10"x8'	12'x12'	\$15,713.22
980257	16'x16'	10"x8'	12'x14'	\$17,022.83
980261	16'x20'	10"x8'	12'x18'	\$19,266.40
980265	18'x10'	10"x8'	14'x8'	\$15,150.78
980269	18'x12'	10"x8'	14'x10'	\$16,274.63
980273	18'x14'	10"x8'	14'x12'	\$17,770.00
980277	18'x16'	10"x8'	14'x14'	\$19,078.57
980285	18'x20'	10"x8'	14'x18'	\$21,511.00
980289	20'x10'	10"x8'	16'x8'	\$16,274.63
980293	20'x12'	10"x8'	16'x10'	\$17,396.41
980297	20'x14'	10"x8'	16'x12'	\$19,078.57
980301	20'x16'	10"x8'	16'x14'	\$20,577.04
980305	20'x18'	10"x8'	16'x16'	\$21,511.00
980309	20'x20'	10"x8'	16'x18'	\$23,194.19
980313	22'x10'	10"x8'	18'x8'	\$17,396.41
980317	22'x12'	10"x8'	18'x10'	\$18,706.02
980321	22'x14'	10"x8'	18'x12'	\$20,388.18
980325	22'x16'	10"x8'	18'x14'	\$22,073.44
980333	22'x20'	10"x8'	18'x18'	\$24,877.38

PERMALITE® SQUARE PULTRUDED COLUMN

Stock #	Overhead	Column Size	Column Center	List Price
980203	12'x10'	10"x8'	8'x8'	\$11,784.40
980207	12'x12'	10"x8'	8'x10'	\$12,533.63
980211	12'x14'	10"x8'	8'x12'	\$13,654.38
980215	12'x16'	10"x8'	8'x14'	\$14,591.44
980219	12'x18'	10"x8'	8'x16'	\$15,337.57
980223	12'x20'	10"x8'	8'x18'	\$16,461.42
980227	14'x10'	10"x8'	10'x8'	\$12,533.63
980231	14'x12'	10"x8'	10'x10'	\$13,654.38
980235	14'x14'	10"x8'	10'x12'	\$14,965.02
980239	14'x16'	10"x8'	10'x14'	\$16,058.94
980243	14'x20'	10"x8'	10'x18'	\$17,022.83
980247	16'x10'	10"x8'	12'x8'	\$14,029.00
980251	16'x12'	10"x8'	12'x10'	\$14,965.02
980255	16'x14'	10"x8'	12'x12'	\$16,085.77
980259	16'x16'	10"x8'	12'x14'	\$17,396.41
980263	16'x20'	10"x8'	12'x18'	\$19,639.98
980267	18'x10'	10"x8'	14'x8'	\$15,526.43
980271	18'x12'	10"x8'	14'x10'	\$16,647.18
980275	18'x14'	10"x8'	14'x12'	\$18,144.61
980279	18'x16'	10"x8'	14'x14'	\$19,454.22
980287	18'x20'	10"x8'	14'x18'	\$21,885.61
980291	20'x10'	10"x8'	16'x8'	\$16,647.18
980295	20'x12'	10"x8'	16'x10'	\$17,770.00
980299	20'x14'	10"x8'	16'x12'	\$19,454.22
980303	20'x16'	10"x8'	16'x14'	\$20,949.59
980307	20'x18'	10"x8'	16'x16'	\$21,885.61
980311	20'x20'	10"x8'	16'x18'	\$23,569.84
980315	22'x10'	10"x8'	18'x8'	\$17,770.00
980319	22'x12'	10"x8'	18'x10'	\$19,078.57
980323	22'x14'	10"x8'	18'x12'	\$20,763.83
980327	22'x16'	10"x8'	18'x14'	\$22,445.99
980335	22'x20'	10"x8'	18'x18'	\$25,252.00

NOTE: Predesigned fiberglass pergolas are prefinished with a white Benjamin Moore Command® coating, Napa rafter tails, double support rafter, no header style. Tranquility® Predesigned fiberglass pergolas are reduced lead-time products.

Outdoor Living List Pricing

TRANQUILITY® PREDESIGNED FREESTANDING FIBERGLASS PERGOLAS

PERMACAST® ROUND TAPERED COLUMN

Stock #	Overhead	Column Size	Column Center	List Price
980000	12'x12'	10"x8'	8'x8'	\$16,085.77
980004	12'x14'	10"x8'	8'x10'	\$17,208.59
980008	12'x16'	10"x8'	8'x12'	\$17,582.17
980012	12'x18'	10"x8'	8'x14'	\$18,706.02
980016	12'x22'	10"x8'	8'x18'	\$20,388.18
980020	14'x12'	10"x8'	10'x8'	\$17,208.59
980024	14'x14'	10"x8'	10'x10'	\$18,518.20
980028	14'x16'	10"x8'	10'x12'	\$19,828.84
980032	14'x18'	10"x8'	10'x14'	\$21,885.61
980036	14'x20'	10"x8'	10'x16'	\$23,380.98
980040	14'x22'	10"x8'	10'x18'	\$24,691.62
980044	16'x12'	10"x8'	12'x8'	\$18,518.20
980048	16'x14'	10"x8'	12'x10'	\$19,828.84
980052	16'x16'	10"x8'	12'x12'	\$20,388.18
980056	16'x18'	10"x8'	12'x14'	\$21,697.79
980060	16'x22'	10"x8'	12'x18'	\$23,756.63
980064	18'x12'	10"x8'	14'x8'	\$20,388.18
980068	18'x14'	10"x8'	14'x10'	\$21,885.61
980072	18'x16'	10"x8'	14'x12'	\$22,633.81
980076	18'x18'	10"x8'	14'x14'	\$23,944.45
980080	18'x22'	10"x8'	14'x18'	\$26,376.88
980084	20'x12'	10"x8'	16'x8'	\$21,697.79
980088	20'x14'	10"x8'	16'x10'	\$23,380.98
980092	20'x16'	10"x8'	16'x12'	\$24,129.18
980096	20'x18'	10"x8'	16'x14'	\$25,439.82
980100	20'x20'	10"x8'	16'x16'	\$26,936.22
980104	20'x22'	10"x8'	16'x18'	\$28,245.83
980108	22'x12'	10"x8'	18'x8'	\$23,008.43
980112	22'x14'	10"x8'	18'x10'	\$24,691.62
980116	22'x16'	10"x8'	18'x12'	\$25,625.58
980120	22'x18'	10"x8'	18'x14'	\$27,123.01
980124	22'x22'	10"x8'	18'x18'	\$29,929.02

PERMALITE® SQUARE COLUMN

Stock #	Overhead	Column Size	Column Center	List Price
980002	12'x12'	10"x8'	8'x8'	\$16,833.97
980006	12'x14'	10"x8'	8'x10'	\$17,956.79
980010	12'x16'	10"x8'	8'x12'	\$18,332.44
980014	12'x18'	10"x8'	8'x14'	\$19,454.22
980018	12'x22'	10"x8'	8'x18'	\$21,137.41
980022	14'x12'	10"x8'	10'x8'	\$17,956.79
980026	14'x14'	10"x8'	10'x10'	\$19,266.40
980030	14'x16'	10"x8'	10'x12'	\$20,577.04
980034	14'x18'	10"x8'	10'x14'	\$22,633.81
980038	14'x20'	10"x8'	10'x16'	\$24,129.18
980042	14'x22'	10"x8'	10'x18'	\$25,439.82
980046	16'x12'	10"x8'	12'x8'	\$19,266.40
980050	16'x14'	10"x8'	12'x10'	\$20,577.04
980054	16'x16'	10"x8'	12'x12'	\$21,137.41
980058	16'x18'	10"x8'	12'x14'	\$22,445.99
980062	16'x22'	10"x8'	12'x18'	\$24,503.80
980066	18'x12'	10"x8'	14'x8'	\$21,137.41
980070	18'x14'	10"x8'	14'x10'	\$22,633.81
980074	18'x16'	10"x8'	14'x12'	\$23,380.98
980078	18'x18'	10"x8'	14'x14'	\$24,691.62
980082	18'x22'	10"x8'	14'x18'	\$27,123.01
980086	20'x12'	10"x8'	16'x8'	\$22,445.99
980090	20'x14'	10"x8'	16'x10'	\$24,129.18
980094	20'x16'	10"x8'	16'x12'	\$24,877.38
980098	20'x18'	10"x8'	16'x14'	\$26,188.02
980102	20'x20'	10"x8'	16'x16'	\$27,684.42
980106	20'x22'	10"x8'	16'x18'	\$28,993.00
980110	22'x12'	10"x8'	18'x8'	\$23,756.63
980114	22'x14'	10"x8'	18'x10'	\$25,439.82
980118	22'x16'	10"x8'	18'x12'	\$26,376.88
980122	22'x18'	10"x8'	18'x14'	\$27,871.21
980126	22'x22'	10"x8'	18'x18'	\$30,677.22

NOTE: Predesigned fiberglass pergolas are prefinished with a white Benjamin Moore Command® coating, Napa rafter tails, double support rafter, no header style. Tranquility® Predesigned fiberglass pergolas are reduced lead-time products.

UNDERSTANDING PERGOLA DIMENSIONS - LENGTH X WIDTH (PROJECTION)

FREESTANDING PERGOLAS

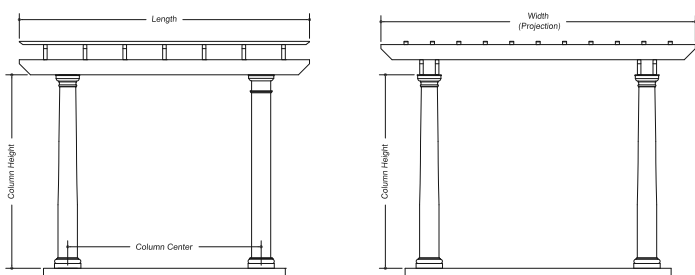

Front View
Beam / Structural rafters run the length of the pergola.

Side View
Rafters run the width (Projection) of the pergola.

ATTACHED PERGOLAS

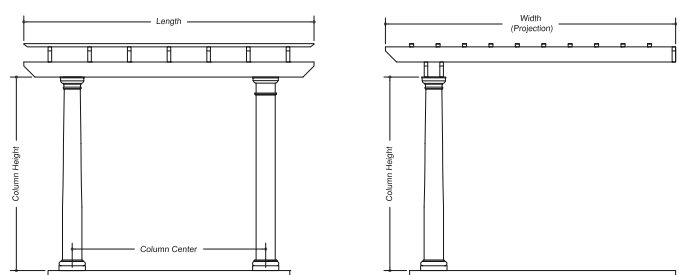

Front View
Ledger runs length of pergola.

Side View
Width (Projection) of the pergola top projects from the structure.

NOTE: Pergola sizes are described as length x width as shown in the examples above.



Phone: (800) 264-4HBG
Fax: (334) 566-4629
www.hbgcolumns.com

Point of Purchase Displays



#05396 – One Round PermaCast® Column, One RoughSawn® Column, One PermaWrap® Square Column, and one Craftsman Column, and Sign. (48" x 18" x 72") (Shown)



#05006
Round and Square PermaCast® Columns
(24" x 18" x 72")
\$634.94 Each

#05397 – One Round and One Square PermaCast® Column, One PermaWrap® Column, One Craftsman Column, and Sign. (48" x 18" x 72")
\$1,456.93 Each



#05166
SmartColumn® Display
10" x 10" x 29"
\$288.96



#04302
PermaRail Plus® Table Top Display
\$74.03



#05376
PermaWrap® 4 Sided
Counter Top Display,
(16 1/2" x 24")
\$182.09



#05377
PermaWrap® 4 Sided
Craftsman Counter Top Display,
(16-1/2" x 24")
\$182.09



#RSPOP Display (RoughSawn Easel)
\$70.61



#PSCTRTOPIH
PermaSnap™ Countertop
\$85.59

#05168 – 8"X6' P1 Sq PermaCast Plus w/RoughSawn
Display – List price = \$ 1436.51



Phone: (800) 264-4HBG
Fax: (334) 566-4629
www.hbgcolumns.com

Point of Purchase Samples



#05580
RoughSawn® Salesman Sample
(12" x 15")
\$91.64



#05579
RoughSawn® 2 Side Sample
\$36.43



#45000
PermaCast® Stand
Sample 28"
\$229.46



#05336
Square PermaCast®
Rep. Sample 24"
\$145.65



#PSSAMPLEH
PermaSnap™ Sample
\$7.73



#05381
PermaCast® Column
Top Sample (18" tall)
\$109.32



#88415 – Woodgrain PVC
\$ 30.00



#05339 – 7" Balustrade
Salesman Sample (11" x 31")
\$218.53



#05167 Smart Column Sample
\$ 272.46



#05404 – Builder Box – Square Column Options
PermaCast® Column, PermaLite® Column, PermaWrap® Column, PermaSnap™ Column,
PermaPost®, RoughSawn®
\$242.92



#04301
PermaRail Plus® Hand Sample
\$48.58



#05318
PermaPost® HD Sample
\$109.32



#05556
Fiberglass Rafter/Purlin Sample
(Rafter- 12"; Purlin 12")
\$49.69
Standard White - Rafter
BMBlack 213240 - Purlin



#05151
PermaLite® Plain Sample
(12" x 15")
\$72.88



#05562
Fiberglass Pergola Top can be used on existing displays
8' x 1'9 1/2"
\$586.79



Phone: (800) 264-4HBG
Fax: (334) 566-4629
www.hbgcolumns.com

Terms and Conditions

Acceptance of Orders

All orders will be accepted, subject to our ability to furnish all products, and may be revoked after acceptance due to conditions beyond our control. Possession of the HB&G price list or catalog is not to be construed as an offer to sell the goods therein.

Order Entry

In order to help us better serve you, we ask that all orders be placed using both the description and the HB&G Stock Keeping Unit (SKU) number.

Order Changes and Cancellations

Changes or cancellations must be communicated in writing by e-mail only. Cancellations of orders for stock merchandise that has been loaded and or shipped must be considered as returned merchandise. Once production has started, special orders can not be cancelled.

Terms

The net invoice amount is due thirty (30) days after the invoice date.

Warehouse and Dealer Drop Shipments

The minimum net \$ drop shipment order that can be included in a HB&G pool truck is \$4,500.00 in shipping zone #1, \$5,000.00 in zone #2, and \$7,000.00 in zone #3, plus dealer drops will incur a Drop Charge of \$250.00. Note: Drop charges may be higher in some distant areas.

Job Site Deliveries

The minimum net \$ job site shipment that can be included in a HB&G pool truck is \$4,500.00 in shipping zone #1, \$5,000.00 in zone #2, and \$7,000.00 in zone #3, plus they will incur a job site delivery charge of \$400.00. A "Job Site Delivery Check List" must be completed prior to the loading of the truck. Note: Delivery charges may be higher in some distant areas.

Shipments and Claims

Our HB&G pool truck responsibility terminates upon delivery of goods to the buyers designated place of delivery and receipt by us of a clear signed receipt that goods were examined and found to be in good condition.

Goods delivered by common carrier are F.O.B. Troy Alabama, and are the property of the consignee at the moment the truck leaves the dock. Freight charges will be prepaid and added to the invoice. The buyer must file any claims with the delivering carrier. A packaging, crating or palletizing charge of 10% of the net value of the product or a minimum charge of \$5.00 will be added to all products to help protect them. HB&G offers no guarantee that the product will arrive undamaged.

FedEx/Motor Freight

A handling charge of 10% of the net value of the product or a minimum of \$5.00 will be added.

Returned Merchandise Authorization (RMA)

- Only current made to stock items that are reported to be in saleable condition and purchased within the last 120 days will be accepted.
- All returned merchandise will be inspected and appropriate action will be taken to put the product into a saleable condition.
- Repair and repackaging charges will be deducted along with a minimum 35% restocking fee.
- All returns must be made within 30 days of the RMA date.
- Returned merchandise shipment must be prepaid. Collect shipments will be refused.

Order Minimums

The minimum net \$ order that can be included in a HB&G pool truck shipment to a distributor is:

Zone 1 \$4,500.00

Zone 2 \$5,000.00

Zone 3 \$7,000.00

PERMACast®
Columns

RoughSawn®

HB&G
PermaRail Plus®

Perma**P**ost®

PERMAWrap
C O L U M N S
Collection

PermaPorch®
Ceiling

III Balustrade
Systems

PermaLite®

SmartColumn®

HB&G
BUILDING PRODUCTS

Phone: (800) 264-4HBG
Fax: (334) 566-4629
www.hbgcolumns.com

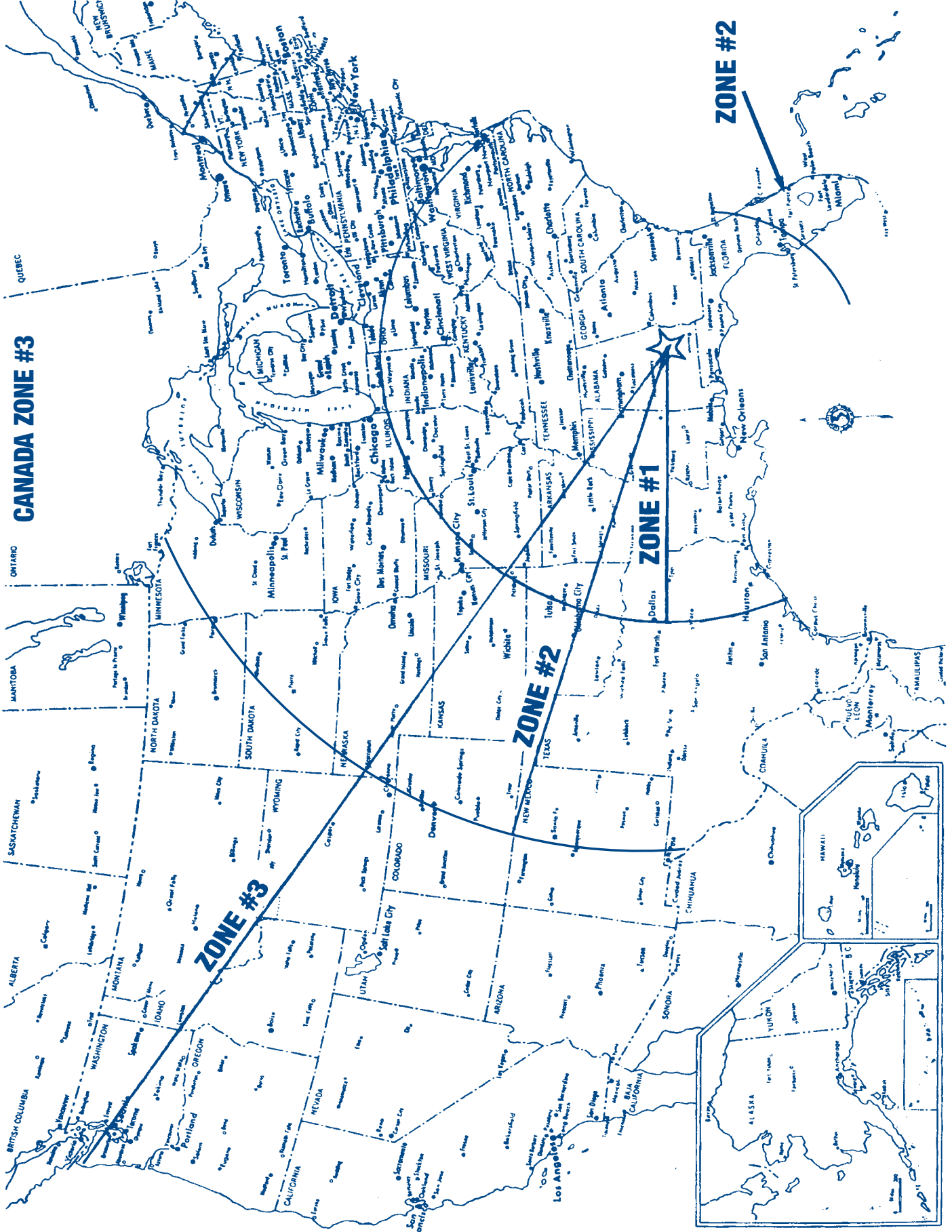

CANADA ZONE #3

ZONE #2

ZONE #1

ZONE #2

ZONE #3

