

Hardware

Effective November 1, 2021

List Prices with Multiplier Option



Type your multiplier (as a decimal) in the Blue Box below and your NET prices will calculate on the following pages. It is the customer's responsibility to make sure their multiplier is correct.

Multiplier:

1.000

Enter 1 for List Price

	Page		Page
Barn Hardware	40-46	Hinge: Spring Invisible	6
Bifold	24-25	Hinge: Spring Sgl	6
Bolts	13	Hinge: Straps	12
ByPass	26-27	Kick Plate	18
Catches	16	Latch Protector	31-32
Clavos	36	Mail Box	29
Closer	17	Pocket Hardware	22-23
Coat Hook	28	Pocket Lock	21
Door Reinforce	33	Push-Pull	19
Gate	35	Rods-Closet	39
Handrail Bracket	20	Screen Combo Hdwe	34-35
Hinge: Double Act	7-9	Shelving	37-38
Hinge: Floor	11	Shutter Ext Interior	47-48
Hinge: Gravity Pivot	10	Stop: Door	14-15
Hinge: Heavy Duty	3-4	Stop: Hinge	15
Hinge: Invisible	5	Strike & Filler	30
Hinge: Piano	11	Viewer	28
Hinge: Residential	2	Window	33

B&B Wood Products, Inc. - 26301 Richmond Road - Bedford Heights, OH 44146

216-292-6555

sales@bbwood.com

This price sheet may be withdrawn without notice. Verify that this is the most recent version.

Residential Hinges



Price per Pair - Steel Hinges - Plain Bearing						
Steel	2500 Square		2514 Radius 1/4"		2558 Radius 5/8"	
	3 1/2"	4"	3 1/2"	4"	3 1/2"	4"
	List Price	List Price	List Price	List Price	List Price	List Price
Satin Brass	17.00	21.00	5.00	21.00	-	-
Bright Brass	13.00	18.00	13.00	18.00	13.00	18.00
Antique Brass	16.00	21.00	16.00	21.00	16.00	21.00
Oil Rub Bronze	14.00	17.00	7.00	9.00	14.00	17.00
Satin Nickel	11.00	14.00	5.00	7.00	11.00	14.00
Pewter	16.00	21.00	16.00	21.00	16.00	21.00
Bright Chrome	13.00	18.00	13.00	18.00	13.00	18.00
Satin Chrome	16.00	22.00	16.00	22.00	16.00	22.00
Flat Black	11.00	15.00	6.00	8.00	11.00	15.00
Add Optional Tips (pr)	NA	NA	NA	NA	NA	NA
Price per Pair - Solid Brass Hinges - Plain Bearing						
Solid Brass	9611 Square		9612 Radius 1/4"		9613 Radius 5/8"	
	3 1/2"	4"	3 1/2"	4"	3 1/2"	4"
	List Price	List Price	List Price	List Price	List Price	List Price
Lifetime Polished Brass	54.00	64.00	54.00	64.00	54.00	64.00
Antique Brass	54.00	64.00	54.00	64.00	54.00	64.00
Oil Rub Bronze	54.00	64.00	54.00	64.00	54.00	64.00
Satin Nickel	54.00	64.00	54.00	64.00	54.00	64.00
Pewter or Black	54.00	64.00	54.00	64.00	54.00	64.00
Bright Chrome	54.00	64.00	54.00	64.00	54.00	64.00
Add Optional Tips (pr)	28.00	28.00	28.00	28.00	28.00	28.00

Thickness: Steel: .085

Thickness Solid Brass .096" - .098"

Hinge pin stops cannot be used with Ball/Steeple Tips.

To use a hinge stop on Solid Brass button tip hinges request a quote on

Template Steel Hinges Square Corner						
Steel	<u>5000 Plain Bearing</u>				<u>5010 Wide Throw</u>	
	3½"	4"	4½"	5"	3½"x5	4"x6
Price per Pair	List Price	List Price	List Price	List Price	List Price	List Price
Satin Brass	26.00	28.00	31.00	49.00	86.00	99.00
Bright Brass	26.00	28.00	31.00	63.00	86.00	
Antique Brass	26.00	28.00	31.00			
Satin Bronze	20.00	24.00	24.00			
Oil Rub Brz (US10B)	26.00	29.00	31.00		97.00	
Brz Black'd (US10A)			24.00			
Satin Nickel	26.00	26.00	31.00		86.00	
Pewter	26.00	28.00	31.00			
Bright Chrome	26.00	28.00	31.00		86.00	133.00
Satin Chrome	26.00	28.00	31.00	56.00		133.00
Flat Black	26.00	26.00	31.00			
Add Ball/Steeple (pr)	24.00	24.00	24.00			
Add NRP (pr)	14.00	14.00	14.00			
Solid Brass						
	<u>962 Plain Bearing Solid Brass</u>					
Price per Pair	3½"	4"	4½"	-	-	-
Bright Brass	62.00	72.00	82.00	-	-	-
Antique Brass	62.00	72.00	82.00	-	-	-
Oil Rub Bronze	62.00	72.00	82.00	-	-	-
Satin Nickel	62.00	72.00	82.00	-	-	-
Pewter	62.00	72.00	82.00	-	-	-
Bright Chrome	62.00	72.00	82.00	-	-	-
Add Ball/Steeple (pr)	28.00	28.00	28.00	-	-	-
Add NRP (pr)	14.00	14.00	14.00	-	-	-

Wide Throw – Width increased, moving barrel away from the door for thicker casing.

Template Steel Ball Bearing Hinges Square Corner						
Steel	<u>BB5000 BALL Bearing</u>				<u>BB5010 Wide Throw</u>	
	3½"	4"	4½"	5"	3½"x5	4"x6
Price per Pair	List Price	List Price	List Price	List Price	List Price	List Price
Satin Brass	40.00	43.00	47.00	60.00	93.00	132.00
Bright Brass	40.00	43.00	47.00	76.00	119.00	158.00
Antique Brass	40.00	43.00	47.00			
Satin Bronze	40.00	43.00				
Oil Rub Brz (US10B)	40.00	43.00	47.00	76.00		
Brz Black'd (US10A)	40.00		47.00			
Satin Nickel	40.00	43.00	47.00	52.00		
Pewter	40.00	43.00	47.00			
Bright Chrome	40.00	43.00	47.00			158.00
Satin Chrome	40.00	43.00	47.00	52.00	106.00	145.00
Flat Black	40.00	43.00	47.00			
Add Ball/Steeple (pr)	24.00	24.00	24.00	24.00		
Add NRP (pr)	14.00	14.00	14.00	14.00		

In printed version Ball Bearing Brass continued on next page

Solid Brass	BB964 Ball Bearing; Square Corner				
	3½"	4"	4½"	5"	
Price per Pair	List Price	List Price	List Price	List Price	
Bright Brass	77.00	88.00	99.00	106.00	
Antique Brass	77.00	88.00	99.00	106.00	
Oil Rub Bronze	77.00	88.00	99.00	106.00	
Satin Nickel	77.00	88.00	99.00	106.00	
Pewter	77.00	88.00	99.00	106.00	
Bright Chrome	77.00	88.00	99.00	106.00	
Add Ball/Steeple (pr)	28.00	28.00	28.00		
Add NRP (pr)	14.00	14.00	14.00		

Soss Invisible Hinges

A	1/2"	1/2"	5/8"	3/4"	1"	1-1/8"	1-3/8"
B	-	-	29/64"	17/32"	23-32"	7/8"	1-1/16"
C	1-3/4"	2-3/8"	2-3/4"	3-3/4"	4-5/8"	4-5/8"	5-1/2"
D	23/64"	23/64"	9/64"	5/32"	7/32"	3/8"	1/2"
E	-	-	5/32"	3/16"	1/4"	1/4"	9/32"
F	-	-	1-11/32"	2-1/16"	2-19/32"	2-7/16"	2-15/16"
G	1/32"	1/16"	3/64"	3/64"	1-16"	3/64"	1/16"
H	23/32"	23/32"	29/32"	1-5/64"	1-7/16"	1-19/32"	1-15/16"
I	-	-	9/32"	3/8"	15/32"	13/32"	15/32"
Min Wood Thick	3/4"	3/4"	1"	1-1/8"	1-3/8"	1-3/4"	2"
HINGE	203	204	208	212	216	218	220
FINISH	List Price	List Price	List Price	List Price	List Price	List Price	List Price
Satin Brass	39.00	40.00	50.00	92.00	146.00	154.00	244.00
Bright Brass	75.00	85.00	104.00	164.00	244.00	292.00	370.00
Ant Brass	87.00	98.00	146.00	214.00	286.00	318.00	406.00
Oil Rub Brz	87.00	98.00	146.00	196.00	260.00	318.00	406.00
Satin Nickel	51.00	56.00	68.00	104.00	172.00	202.00	328.00
Bright Chrome	75.00	85.00	114.00	164.00	244.00	292.00	370.00
Satin Chrome	43.00	44.00	56.00	92.00	146.00	154.00	244.00
Black	46.00	49.00	64.00	106.00	172.00	182.00	276.00

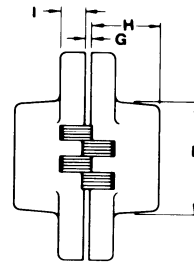
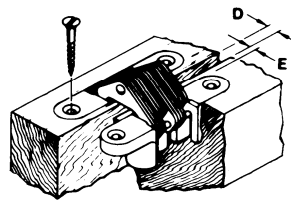
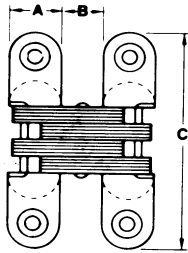

See website for proper [hinge spacing](#) and usage.

Single Acting Spring Hinge

Price per Pair	LB4310 Square			LB4311 1/4"R		LB4312 5/8"R	
	3 1/2"	4"	4 1/2"	3 1/2"	4"	3 1/2"	4"
	List Price	List Price	List Price	List Price	List Price	List Price	List Price
Satin Brass	42.00	45.00	69.00	39.00	42.00	39.00	42.00
Bright Brass	42.00	45.00	72.00	39.00	42.00	39.00	42.00
Antique Brass	42.00	45.00		39.00	42.00	39.00	42.00
Satin Bronze	42.00	45.00		39.00	42.00	39.00	42.00
Oil Rub Bronze	42.00	45.00	49.00	39.00	42.00	39.00	42.00
Satin Nickel	42.00	45.00	47.00	39.00	42.00	39.00	42.00
Pewter	42.00	45.00		39.00	42.00	39.00	42.00
Bright Chrome	42.00	45.00		39.00	42.00	39.00	42.00
Satin Chrome	51.00	56.00	47.00	31.00	34.00	31.00	34.00
Flat Black	42.00	45.00		39.00	42.00	39.00	42.00

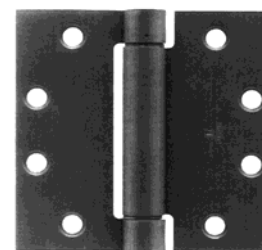

LB4310C = Square Corner
LB4311C = 1/4" Radius

Full Mortise; Steel, ANSI K81071F - Contract Grade - BHMA certified Grade 1 for one million cycles
C U/L Listed Grade 1 and BHMA/ANSI A156.17 Grade 1

Easily adjustable spring tension. ANSI template screw hole pattern, Self lubricating bearings

Pivot point aligns with commercial butt hinges gauge .123 to .134

Gauge: 3-1/2"=.130, 4"=.130; 4-1/2"=0.134

Number of Holes: 6 on 3-1/2", 8 on 4" and 4-1/2"

Recommended Maximum Labeled Door Size: 3' Wide by 7' High

Recommended Maximum Door Weight:

70 lbs (3-1/2"), 85 lbs (4"), 115 lbs (4-1/2") with two spring hinges and one butt hinge

90 lbs (3-1/2"), 115 lbs (4"), 150 lbs (4-1/2") with three spring hinges

<u>Invisible Spring Hinge List EACH</u>				
	212IC	216IC	218IC	220IC
	List Price	List Price	List Price	List Price
Satin Brass	213.00	242.00	264.00	318.00
Bright Brass	252.00	309.00	313.00	375.00
Oil Rub Bronze	265.00	315.00	327.00	379.00
Satin Nickel	234.00	279.00	287.00	350.00
Bright Chrome	252.00	309.00	313.00	375.00
Satin Chrome	213.00	242.00	264.00	318.00
Black	222.00	261.00	272.00	324.00

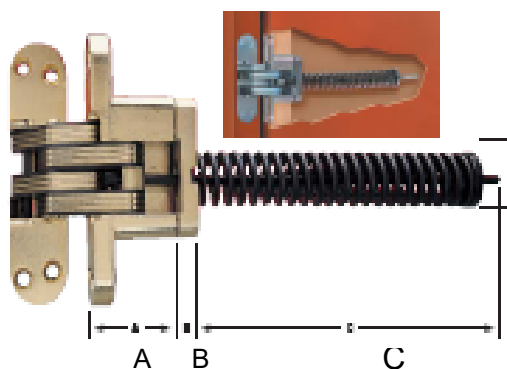

Door Thickness	1-1/8"	1-3/8"	1-3/4"	2"
A	1-5/64"	17/16"	1-41/64"	1-15/16"
B	3/8"	3/8"	3/8"	3/8"
C	5-11/32"	6-1/4"	7"	7"
D	1/2"	3/4"	1"	1"

Models 216IC, 218IC, 220IC rated for 20-minute.

No Hinge Barrel seen when door is closed. Install inside the Door or inside the jamb.

212IC for 1-1/8" door thickness. Allow one closer for every 28 lbs. of door weight or portion thereof.

216IC for 1-3/8" door thickness. Allow one closer for every 55 lbs. of door weight or portion thereof.

218IC for 1-3/4" door thickness. Allow one closer for every 55 lbs. of door weight or portion thereof.

220IC for 2" door thickness. Allow one closer for every 55 lbs. of door weight or portion thereof.

Double Acting Ball Bearing Hinges

	1515	1515H	3029-3	3029-4	3029-5	3029-6	3029-7	3029-8
Price per Pair	List Price	List Price	List Price	List Price	List Price	List Price	List Price	List Price
Satin Brass	97.00	131.00	127.00	135.00	186.00		254.00	
Bright Brass		147.00	143.00	151.00	212.00	229.00	284.00	
Satin Bronze			127.00	135.00	186.00	205.00	254.00	373.00
Oil Rub Bronze					276.00	295.00		
Satin Nickel					245.00			
Zinc Plated	97.00							
Satin Chrome			164.00	172.00	238.00			477.00
Flat Black					154.00	170.00		

See next tab or store.bbwood.com for door sizes and weight chart

3029 Hinges will fit into standard full mortise hinge cutout in metal door; but if standard hinge locations are furnished on 1-3/4" hollow metal doors, we recommend using 3029-8x4.5 hinges for maximum support. Contact our office for pricing.

	1514
Price per Pair	List Price
Satin Brass	93.00
Bright Brass	103.00

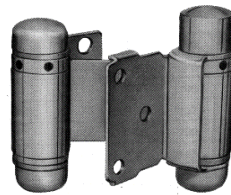

1514 & 1515

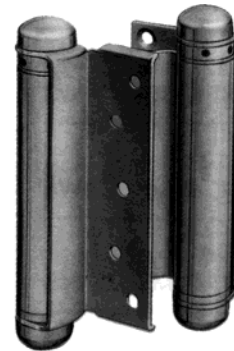

3029 Series

[Table of Contents](#)

Item Number	2 Hinges per Door		3 Hinges per Door		Door Thickness	Min. Door Height
	Door Weight	Door Width	Door Weight	Door Width		
1515	18	1'6"	--	--	7/8" to 1"	3'6"
1515-H	18	1'6"	--	--	1-1/8 to 1-1/2"	3'6"
3029-3	35	2'0"	39	2'8"	3/4" to 1"	5'0"
3029-4	60	2'4"	75	3'0"	7/8" to 1-1/4"	6'8"
3029-5	65	2'8"	93	3'0"	1-1/8 to 1-1/2"	6'8"
3029-6	75	2'8"	107	3'0"	1-1/4 to 1-3/4"	7'0"
3029-7	82	3'0"	120	3'6"	1-3/8 to 2"	7'0"
3029-8	103	3'6"	143	4'0"	1-1/2 to 2"	7'0"
3029-5x3.5*	65	2'8"	93	3'0"	1-3/8"	6'8"
3029-6x4.5*	75	2'8"	107	3'0"	1-3/4"	7'0"
3029-8x4.5*	103	3'6"	143	4'0"	1-3/4"	7'0"

#3029 - Door flange mortised in door.

- Jamb flange surface applied to face of frame.
- Recommend 1-1/2 pair hinges per door.
- Center hinge should be installed as close as possible to top hinge for support.
- Do not use on doors with hinge edge beveled.

#1515 - Door flange surface applied or mortised.

- Jamb flange surface applied.

Hinges are Non-Handed.

Floor Hinge

	7811	7813HD	7805
	List Price	List Price	List Price
Satin Brass	115.00		14.00
Bright Brass	134.00		17.00
Antique Brass	134.00		
Satin Bronze	110.00		
Oil Rub Bronze	159.00	266.00	
Satin Nickel	144.00	240.00	
Pewter	159.00		21.00
Bright Chrome	159.00		17.00
Satin Chrome	144.00	240.00	18.00
Flat Black	109.00	181.00	

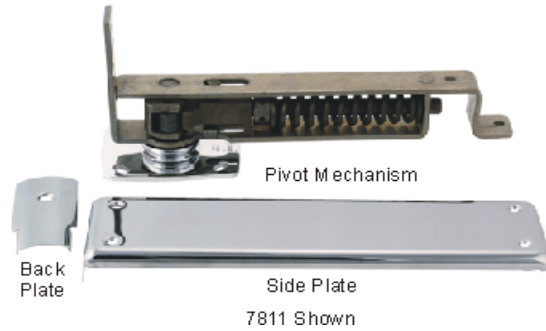

7805 Jamb brackets may be purchased as a separate item to allow conversion of any pivot from the standard floor mount to jamb mounted.

7813HD HEAVY DUTY: No Hold Open Feature

7813HD hinge can be used for doors weighing minimum of 90 lbs. up to 150 lbs. Do not use this hinge if doors are less than 90 lbs.

- STEEL MECHANISM
- DOUBLE ACTING
- ANTI FRICTION BEARING
- ADJUSTABLE SPRING TENSION
- HOLD OPEN AT APPROXIMATELY 85 DEGREES
- NON-HANDED
- MAXIMUM DOOR WIDTH 3'0"
- WEIGHTS UP TO 90 LBS (*7813HD for 150lbs)

Gravity Pivots	7512H	173
Finish	List Price	List Price
Satin Brass	-	17.00
Bright Brass	72.00	-
Oil Rub Bronze	93.00	-
Satin Nickel	82.00	-
Satin Chrome	82.00	-

Order 2 sets 7512 for each pair of doors
 Order 1 set 173 for each pair of doors

7512-H Features

Hold Open at 90 Degrees

- Steel
- Double Acting
- Door weight closes door - No Springs
- Non-Handed
- Maximum Door Size & Weight
 - Width - 30" max
 - Weight - 50 lbs. max
- Flat Door Bracket - Doors 7/8" TO 1 5/8" thick
- Flat Jamb Bracket - 1 1/4" WIDE

Notes: Round the jamb edge of door 7/8" radius. Top clearance required 3/4" (5/8" lift).
 Pivot side of door to jamb requires 5/32". Made in USA.

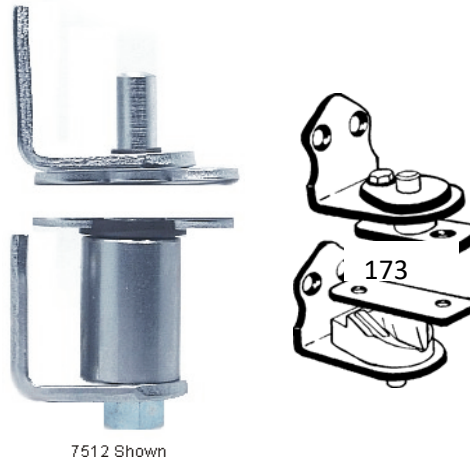

7512 Shown

173 Swing and Stay Hinge

Door weight closes door - No Spring

3/4" to 1-3/8" thick doors.

Max door weight up to 50 Lbs.

Sold as a set to hang two Doors

Satin Brass

This chart is used to determine the size of Cafe doors required. Allow 1/8" clearance between center of doors for swing. The side jamb clearance noted needs to be doubled if hanging a pair of cafe doors.

<u>Door thickness</u>	<u>Jamb Side Clearance (per side)</u>
3/4"	1/4"
1-1/8"	3/8"
1-3/8"	1/2"

Piano (Continuous) Hinges

Piano Hinges			Brass	Nickel	ORB
ITEM	Open Width	Length	Brass List	Nickel List	ORB List
H11624	1-1/16"	24"	8.00	-	-
H11636	1-1/16"	36"	14.00	-	-
H11648*	1-1/16"	48"	14.00	-	-
H11672*	1-1/16"	72"	18.00	28.00	-
H11424	1-1/4"	24"	8.00	8.00	-
H11436	1-1/4"	36"	12.00	12.00	-
H11448	1-1/4"	48"	12.00	-	-
H11472	1-1/4"	72"	14.00	14.00	-
H11224	1-1/2"	24"	9.00	-	-
H11236	1-1/2"	36"	12.00	-	-
H11248	1-1/2"	48"	47.00	47.00	47.00
H11272	1-1/2"	72"	64.00	64.00	64.00
H20024	2"	24"	10.00	10.00	-
H20036	2"	36"	13.00	13.00	-
H20048	2"	48"	15.00	-	-
H20072*	2"	72"	20.00	30.00	-

*H20072, H11648 Brass, H11672 Brass are closeouts - verify stock before selling

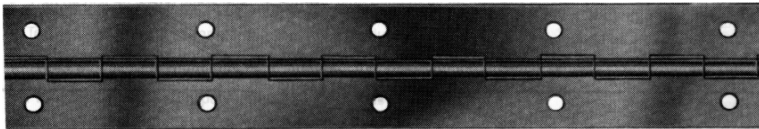

Strap Hinges

Hinge Strap: Rough					
Item	Length	Height Pad	Width Pad	Gauge	Black List Ea
R5	9"	3-1/8"	1-3/8"	0.120	27.00
R6	13"	3-1/8"	1-3/8"	0.120	31.00
R7	17"	4"	2"	0.155	52.00
R8	20-1/2"	4"	2"	0.155	58.00
RG	15-5/8"	4"	2"	0.155	54.00
RH	19-5/8"	4"	2"	0.155	58.00
Dummy Hinge Strap: Rough - use with butt hinges					
Item	Length	Strap Width at Hinge	Gauge	List Ea	
R1	22-1/4"	1-9/16"	0.155	34.00	
R2	18-3/4"	1-9/16"	0.155	32.00	
R3	28-5/16"	3"	0.155	89.00	
RC	8-3/4"	1-3/8"	0.155	12.00	
RD	14-1/4"	1-3/8"	0.155	21.00	
RE	17-1/4"	1-9/16"	0.155	28.00	
RF	21-1/4"	1-9/16"	0.155	33.00	
Hinge Strap: Smooth					
Item	Length	Height Pad	Width Pad	Gauge	List Ea
A5	10"	3-1/8"	1-3/8"	0.120	26.00
A6	13"	3-1/8"	1-3/8"	0.120	28.00
A8	17-3/4"	3-1/8"	1-3/8"	0.120	34.00
AN	15-5/8"	4"	2"	0.155	56.00
AP	19-5/8"	4"	2"	0.155	63.00
Dummy Hinge Strap: Smooth - use with butt hinges					
Item	Length	Strap Width at Hinge	Gauge	List Ea	
AB	14"	1-5/8"	0.155	20.00	
AD	18-3/4"	1-5/8"	0.155	22.00	
AF	24"	1-3/4"	Alum	72.00	
AG	31"	1-15/16"	Alum	102.00	
AL	17-1/4"	1-9/16"	0.155	28.00	
AM	21-1/4"	1-9/16"	0.155	32.00	



Flush Bolts 6"	Square	Radius
3/4" X 6"	3310 List	3300 List
Bright Brass	16.00	15.00
Antique Brass	17.00	15.00
Oil Rub Bronze	16.00	15.00
Satin Nickel	16.00	15.00
Pewter	22.00	22.00
Flat Black	22.00	15.00
Bright Chrome	17.00	15.00
Satin Chrome	16.00	15.00

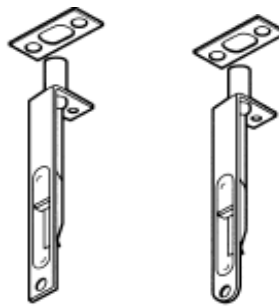

3310

3300

1358 UL Flush Bolt *12"	
1" x 6-3/4"	List Price
Bright Brass	34.00
Satin Brass	46.00
Antique Brass	34.00
Satin Bronze	34.00
Oil Rub Bronze	34.00
Satin Nickel	36.00
Pewter	58.00
Flat Black	36.00
Bright Chrome	34.00
Satin Chrome	31.00
*18" Rod	9.00



1358

557 UL Flush Bolt	
1" x 6-3/4"	List Price
Bright Brass	39.00
Satin Brass	-
Antique Brass	-
Satin Bronze	48.00
Oil Rub Bronze	45.00
Satin Nickel	-
Pewter	-
Flat Black	-
Bright Chrome	-
Satin Chrome	45.00



557

Dutch Door Bolts	4" Long	Quadrant
	1630 List	56 List
Bright Brass	36.00	77.00
Antique Brass	50.00	93.00
Oil Rub Bronze	41.00	93.00
Satin Nickel	50.00	93.00
Pewter	50.00	93.00
Black, Flat	50.00	93.00
Bright Chrome	33.00	93.00
Satin Chrome	33.00	93.00



1630



56

Surface Bolts	3"	4"	6"
	SB3 List	SB4 List	SB6 List
Bright Brass	9.00	11.00	16.00
Antique Brass	19.00	18.00	27.00
Oil Rub Bronze	14.00	15.00	28.00
Satin Nickel	17.00	19.00	27.00
Pewter	-	26.00	31.00
Bright Chrome	12.00	11.00	17.00
Satin Chrome	12.00	14.00	20.00



Spring Stop	4217 List	4674 List
Length	<u>3-1/8"</u>	<u>3-3/4"</u>
Bright Brass	1.13	2.50
Antique Brass	1.90	2.00
Satin Bronze	1.70	-
Oil Rub Bronze	1.13	1.90
Satin Nickel	1.13	1.90
Pewter	2.67	2.40
Bright Chrome	1.37	2.30
Satin Chrome	1.37	2.00
Black	2.05	2.30



SOLID BRASS			
Solid Stop	4680 List	60 List	62 List
Length	<u>3-3/4"</u>	<u>3-3/4"</u>	<u>4-1/2"</u>
Bright Brass	5.60	13.70	12.00
Antique Brass	-	14.50	-
Oil Rub Bronze	5.60	17.80	-
Satin Nickel	5.60	17.80	-
Pewter	-	33.00	-
Bright Chrome	-	18.90	14.30
Satin Chrome	-	18.90	14.30
Black	5.60	18.90	-



Note: 62 subject to stock on hand

Wall Bumper	407 List
Bright Brass	4.50
Antique Brass	5.60
Satin Bronze	5.60
Oil Rub Bronze	5.00
Satin Nickel	5.00
Pewter	13.50
Bright Chrome	5.30
Satin Chrome	5.00



2-1/2" Diameter

Hinge Stops	4210 List	69 List	1503 List	9507 List
Bright Brass	1.90	4.90	2.90	10.80
Antique Brass	2.70	4.90	4.00	-
Satin Bronze	2.70	4.90	-	-
Oil Rub Bronze	1.90	4.70	2.90	11.50
Satin Nickel	1.90	4.70	2.90	10.80
Pewter	4.20	4.90	4.00	-
Bright Chrome	2.30	4.90	2.90	10.80
Satin Chrome	2.30	4.90	2.90	-
Black	2.30	4.90	2.90	-
White	3.50	-	-	-



[4210](#)



[69](#)



[1503](#)



[9507](#)

Printed version Wall Bumper, Floor Stop and Drop Arm Shown on Next Page

Wall Bumper	1400 List
Satin Chrome	8.50
ORB, Chrome, Satin Brass	13.30



1" Diameter

Floor Stop	440 List	442 List
Bright Brass	7.20	12.50
Antique Brass	7.40	12.50
Satin Bronze	8.60	14.00
Oil Rub Bronze	8.30	12.80
Satin Nickel	8.30	16.20
Pewter	19.00	23.00
Bright Chrome	7.70	13.20
Satin Chrome	7.00	9.90



[440 1" High](#)



[442 1-1/4" High](#)

Floor Stop	FS448 List
Bright Brass	35.00
Oil Rub Bronze	33.00
Satin Nickel	43.00
Bright Chrome	52.00
Satin Chrome	35.00
Black	43.00



3" High

Floor Stop	4635 List
Bright Brass	5.20



1-3/8" High

Drop Arm 5"	4649 List
Bright Brass	16.40
Satin Nickel	16.40
Oil Rub Bronze	16.40



Kick Down

Ball Catches	347 List	DB75 List	Strike List
Bright Brass	19.00	6.00	5.00
Antique Brass	20.00	7.00	5.00
Satin Bronze	21.00	-	-
Oil Rub Bronze	21.00	6.00	5.00
Satin Nickel	20.00	6.00	5.00
Pewter	20.00	7.00	5.00
Black	21.00	-	5.00
Bright Chrome	21.00	-	5.00
Satin Chrome	21.00	7.00	5.00

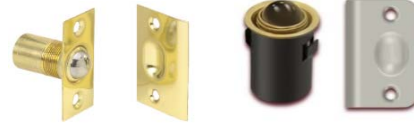

[347 Online](#)

[DBC75](#)

[Strike Online](#)

Roller Catches	335 List	1700 List	1702 List	1704 List
Bright Brass	20.70	45.00	45.00	45.00
Antique Brass	24.80	-	-	-
Satin Bronze	-	50.00	-	-
Oil Rub Bronze	24.80	49.00	49.00	49.00
Satin Nickel	25.80	50.00	50.00	77.00
Pewter	22.00	63.00	63.00	77.00
Black	-	57.00	70.00	77.00
Bright Chrome	26.30	57.00	70.00	77.00
Satin Chrome	24.80	38.00	38.00	38.00

Magnetic Catch	magnetic List
PLS24PRO	23.00

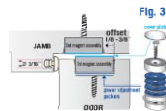

[335](#)



[1700](#)



[1702](#)



[1704](#)

Door Closers

Series 50	Size	Silver List	Brown List
S52BC	2	see 5014	\$90.00
S53BC	3	see 5014	\$90.00
S55BC	5	\$90.00	\$90.00
5014 Adjustable ADA	1-4	\$93.00	\$93.00
5036 Adjustable ADA	3-6	\$93.00	\$93.00

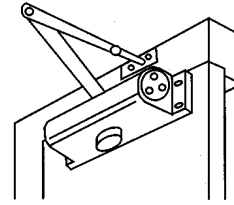

Choosing the correct Series 50 closer

50 series	Dr 26"-30"	Dr 30"-36"	Dr 36"-42"
Exterior	53 or 5014	5014	55 or 5036
Interior	52 or 5014	53 or 5014	5036

Medium Duty

Series SC81	Size	Alum List	Drk Brz List
SC81	1-6	\$216.00	\$216.00



Hold Open	Finish	List Price
SN123HO	Silver, Black, White, Brown	\$75.00
Max Door Width		3'6"
Max Door Weight		150 lbs.
Max Open Angle Door Mount		169°
Max Angle at which Hold-Open Engages		110°

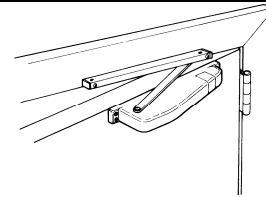

V1342 Screen & Storm Closers		List Price
Black	Door Opens about 85 degrees	\$29.00
Aluminum	Door Opens about 85 degrees	\$29.00



[Move to Storm Hardware](#)

[Kick Plates](#)

Code	Finish	Gauge	6x28 List	6x30 List	6x32 List	6x34 List	6x40 List	8x28 List	8x30 List	8x32 List	8x34 List	8x40 List
BT	Brasstone Alum	.04	31.00	33.00	35.00	37.00	44.00	34.00	37.00	39.00	41.00	49.00
505	Bright Brass-10Yr	.05	131.00	136.00	150.00	154.00	187.00	170.00	182.00	194.00	199.00	242.00
605	Bright Brass	.05	83.00	89.00	90.00	95.00	112.00	89.00	102.00	112.00	108.00	127.00
606	Satin Brass	.05	89.00	96.00	96.00	102.00	120.00	90.00	102.00	112.00	109.00	128.00
609	Antique Brass	.05	97.00	#####	111.00	114.00	138.00	109.00	116.00	128.00	132.00	160.00
612	Satin Bronze	.05	101.00	108.00	116.00	119.00	144.00	115.00	123.00	135.00	139.00	169.00
613	Oil Rub Bronze	.05	97.00	104.00	111.00	114.00	138.00	108.00	119.00	127.00	130.00	158.00
619	Satin Nickel	.05	89.00	96.00	102.00	105.00	127.00	115.00	124.00	132.00	136.00	160.00
622	Black Anod Alum	.04	31.00	33.00	35.00	37.00	44.00	34.00	37.00	39.00	41.00	49.00
626	Satin Chrome	.05	102.00	106.00	117.00	124.00	146.00	114.00	118.00	130.00	134.00	162.00
628	Aluminum	.05	24.00	26.00	28.00	29.00	34.00	27.00	29.00	32.00	32.00	38.00
629	Bright Stain Steel	.05	60.00	64.00	68.00	72.00	85.00	68.00	72.00	77.00	82.00	96.00
630	Satin Stain Steel	.05	25.00	27.00	29.00	31.00	36.00	30.00	32.00	34.00	36.00	42.00
630	Satin Stain Steel	.038	26.00	28.00	30.00	32.00	38.00	30.00	32.00	35.00	37.00	43.00
670	Satin Nick Alum	.04	31.00	33.00	35.00	37.00	44.00	34.00	37.00	39.00	41.00	49.00
716	Dark Anod Alum	.04	31.00	33.00	35.00	37.00	44.00	34.00	37.00	39.00	41.00	49.00
620*	Pewter	.05	-	-	-	50.00	-	-	-	-	50.00	-

Magnetic Backs ADD \$40 Stock in 8 x 34 Satin Nickel Bright Brass and 10 Year Brass





[70](#)

3-1/2x15

[7014](#)

3-1/2x15



[230](#)

3/4" x 3-7/8"

Push/Pull Plates	70 List	7014 List
Bright Brass	33.00	91.00
Antique Brass	65.00	94.00
Satin Bronze	40.00	127.00
Oil Rub Bronze	70.00	102.00
Satin Nickel	40.00	128.00
Pewter	73.00	131.00
Black	33.00	108.00
Bright Chrome	40.00	122.00
Satin Chrome	38.00	114.00
Aluminum	16.00	42.00
Bright Stain Steel	21.00	72.00
Satin Stain Steel	15.00	57.00

Edge Pull	P230 List
Bright Brass	19.00
Antique Brass	21.00
Satin Bronze	19.00
Oil Rub Bronze	21.00
Satin Nickel	21.00
Pewter	21.00
Black	21.00
Bright Chrome	21.00
Satin Chrome	21.00



[218](#)

[221](#)

[222](#)

[223](#)

[227](#)

	1" Diam.	2-7/16" Diam	1-5/16" x 3-1/8"	1-5/16" x 3-9/16"	1-3/4" x 3-5/8"
Flush Pull	P218				
	List	P221 List	P222 List	P223 List	P227 List
Bright Brass	3.70	5.00	29.00	8.90	13.30
Antique Brass	-	5.40	33.20	13.00	15.80
Satin Bronze	7.00	-	-	-	19.80
Oil Rub Bronze	7.00	5.90	33.20	9.90	15.40
Aged Bronze	-	6.10	-	-	-
Satin Nickel	4.50	5.70	32.20	9.50	14.80
Pewter	7.00	7.70	28.80	13.00	-
Black	6.00	6.30	33.20	10.60	16.40
Bright Chrome	6.00	6.30	33.20	10.60	16.40
Satin Chrome	6.00	6.30	33.20	10.60	16.40

Item	Size	List
P221SQ	2-1/2" x 2-1/2"	24.20
P2276	1-3/4" x 6"	43.50
P2277	2" x 7"	52.00
P22710	2" x 10"	71.30



P221SQ



P2276

P2277

P22710



Projection	HR4235	HR059	HR059	HR312
	List	A List	B List	List
	<u>2-1/4"</u>	<u>2-7/16"</u>	<u>2-7/16"</u>	<u>3-1/2"</u>
Bright Brass	5.00	5.30	27.20	23.40
Antique Brass	-	5.30	41.30	-
Satin Bronze	-	5.30	-	-
Oil Rub Bronze	4.70	5.30	32.20	23.80
Satin Nickel	4.70	5.30	32.20	24.80
Pewter	5.00	-	34.20	-
Bright Chrome	6.30	-	38.80	-
Satin Chrome	4.50	5.30	37.60	-
Black	-	6.90	-	-
White	-	7.30	-	-



Projection	HR601	HR606	HR158	HR159
	List	List	List	List
	<u>2-3/4"</u>	<u>2-3/4"</u>	<u>3-3/8"</u>	<u>2-1/4"</u>
Bright Brass	10.50	13.00	14.00	31.70
Antique Brass	10.50	-	0.00	-
Satin Bronze	-	-	-	31.70
Oil Rub Bronze	11.00	13.00	14.00	38.10
Satin Nickel	10.00	13.00	14.00	38.10
Pewter	13.00	-	21.00	38.10
Bright Chrome	11.00	-	21.00	-
Satin Chrome	11.00	-	21.00	39.70
Black	10.00	-	21.00	-
White	0.00	-	21.00	-

[HR301 Powder Coat in stair guide](#)

[HR161-Online](#)



[Table of Contents](#)

[Pocket Bolt](#)

Pocket Door Locks



[PDL100](#) Passage [PDL101](#) Privacy [PDL101-134](#) Privacy [PDL2101](#) Passage [PDL2102](#) Privacy

Cut Out 1-3/4x2-1/4 1-3/4x2-1/4 1-3/4x2-1/4 1-3/4x3-1/8 1-3/4x3-1/8

	PDL100 List	PDL101 List	PDL101-134 List	PDL2101 List	PDL2102 List
Door Thickness	up to 1-3/4"	1-3/8"	up to 1-3/4"	up to 1-3/4"	up to 1-3/4"
Bright Brass	12.50	15.00	18.00	45.00	61.30
Antique Brass	13.70	17.00	20.00	45.00	61.30
Satin Bronze	13.50	15.00	-	-	-
Oil Rub Brz	13.50	15.00	18.00	45.00	61.30
Aged Bronze	21.50	30.00	-	-	-
Satin Nickel	15.90	20.00	23.00	45.00	61.30
Pewter	17.70	21.00	24.00	45.00	61.30
Black	17.30	21.00	24.00	45.00	61.30
Bright Chrome	12.50	14.00	17.00	45.00	61.30
Satin Chrome	12.80	14.00	17.00	0.00	0.00



[1521](#) [21](#)

1-3/8" Doors Pair Dummy

	P1521 List	P21 List
Tubular Pocket	40.00	16.00
Bright Brass	40.00	16.00
Satin Nickel	36.00	16.00
Black	33.00	16.00



Mortise Pocket Door Locks

[Priced on store.bbwood.com](#)

More finishes & 1-3/4" thick on store.bbwood.com



[42](#)

Pocket Bolt	P42 List
Bright Brass	20.00
Antique Brass	22.00
Oil Rub Bronze	23.00
Satin Nickel	22.00
Pewter	23.00
Black	23.00
Bright Chrome	23.00
Satin Chrome	23.00

[Table of Contents](#)

[Parts](#)

Pocket Track & Hanger Kits

50 Lbs.	Description	List
2850-96	For up to 4'0" Door	44.00

Includes door guide for 1-3/8" door
Rough Opening = Door Height + 4-1/2"

150 Lbs.	Description	List
Kit.PD150-48	For 2'0" Door	34.70
Kit.PD150-60	For 2'6" Door	37.80
Kit.PD150-72	For 3'0" Door	41.00
Kit.PD150-96	For 4'0" Door	57.20
SC6320	Add Soft Close PD150	63.80

Includes door guide for 1-3/8" door
Rough Opening = Door Height + 4-1/2"
 For 1-3/4" doors order guide PD250-72
 If adding soft close min door width 24"
 If adding soft close & open min door width 28"

250 Lbs.	Description	List
Kit.PD250-48	For 2'0" Door up to 250 lb	48.70
Kit.PD250-60	For 2'6" Door up to 250 lb	51.80
Kit.PD250-72	For 3'0" Door up to 250 lb	55.00
Kit.PD250-96	For 4'0" Door up to 250 lb	71.20

Includes door guide for 1-3/8" door
Rough Opening = Door Height + 4-1/2"
 For 1-3/4" doors order guide PD250-72

400 Lbs.	Description	List
Kit.PD400-48	For 2'0" Door up to 400 lb	159.00
Kit.PD400-72	For 3'0" Door up to 400 lb	151.00
Kit.PD400-96	For 4'0" Door up to 400 lb	172.00

Minimum door thickness 1-1/8"
Rough Opening = Door Height + 4-1/2"

Knock Down Pocket Kits 4-9/16 & 6-9/16 Wall		
2x4 Stud	Height/Load	List
153068	4-9/16": 6'8"/125 lbs	178.00
153070	4-9/16": 7'0"/200 lbs	205.00
153080	4-9/16": 8'0"/200 lbs	235.00
153090	4-9/16": 9'0"/200 lbs	294.00
1060SOFT	Add Soft Close 1530	75.80
2x6 Stud	Height / 200lb	List
15603068	6-9/16": 6'8"	250.00
15603070	6-9/16": 7'0"	278.00
15603080	6-9/16": 8'0"	302.00
15603090	6-9/16": 9'0"	394.00
1060	Add Soft Close 1560	57.70

Kits may ship as Johnson or Generic Mfg
 For 3/0 widths & can cut to smaller widths
 For 1" to 1-3/8" doors to 125 lbs
Rough Opg.= Door Ht+4-1/2"
 If adding soft close min door width 24"
 If adding soft close & open min door width 28"
 For 3/0 & marked to cut to smaller widths
 For 1" to 3" thick doors to 200 lbs
Rough Opg.= Door Ht.+5"
 If adding soft close min door width 24"
 If adding soft close & open min door width 28"

[Assembled Pocket Frames - Priced in Section 5](#)

[Bypass 1562 Pocket Kit - Call for Quote](#)

Designed for two 1-3/8 bypassing doors in a standard 2 x 6 wall or steel stud wall. The 1562 allows architects and designers to specify large room openings with minimum wall obstruction for "clean and open" living spa
 For widths from 18" to 36" and Heights up to 9'. Min. Wall is 2x6.



[Pocket Door Parts](#)

PD150, PD250 Parts		List
PD150 HDW	Hanger Set (Pair) 150 lb	16.00
PD250-71	Split Floor Guide - Pair	7.00
PD250-72	Floor Guide 1-3/4" Doors	9.00
PD250-74	Floor Guide 1-3/8" Doors	8.00
PD250-77	Pocket Bumper: Set of 4	3.00
PD250N-01-47	Track for 2/0 (44-3/4)	18.00
PD250N-01-55	Track for 2/4 (52-3/4)	20.00
PD250N-01-59	Track for 2/6 (56-3/4)	21.00
PD250N-01-63	Track for 2/8 (60-3/4)	22.00
PD250N-01-71	Track for 3/0 (68-3/4)	24.00
PD250N-01-95	Track for 4/0 (92-3/4)	40.00
PD250 HDW	Hanger Set (Pair) 250 lb	30.00

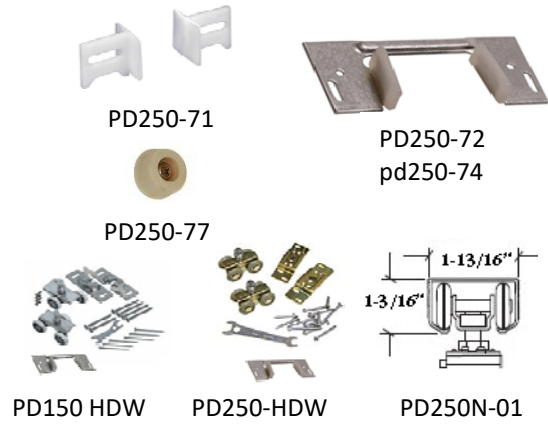

Johnson including 1530, 1560, PD400		List
10	Center guide post 1"H, Pair	8.00
100-48	Track for 2/0: 1530, 1568	33.00
100-60	Track for 2/6: 1530, 1568	41.00
100-72	Track for 3/0: 1530, 1568	48.00
100-96	Track for 4/0: 1530, 1568	68.00
1120	Hanger Ea 125lb for 100 track	8.80
1125	Hanger Ea 200lb for 100 track	17.00
1550	Split Floor Guide - Pair	1.00
1555	Converging Dr Kit 1530, 1560	15.00
1575	Adaptor 1-3/4" Doors 1530	13.00
200-48	Track for 2/0: PD400	84.00
200-72	Track for 3/0: PD400	89.00
200-96	Track for 4/0: PD400	117.00
2020	Hanger Ea. 400lb for 200 Track	47.00
2030	Guide Post Each. 1.21"H	5.00
2031	Guide Post Hvy Each. 1.21"H	6.00
2038	Floor Guide 1-3/8" Doors	7.00
2802	Hanger Each for 2850 pockets	8.00

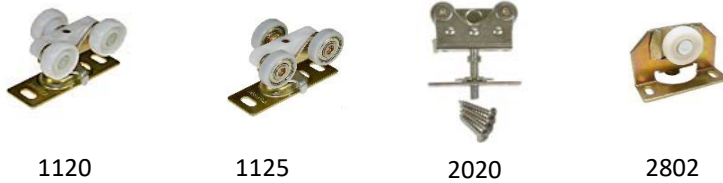
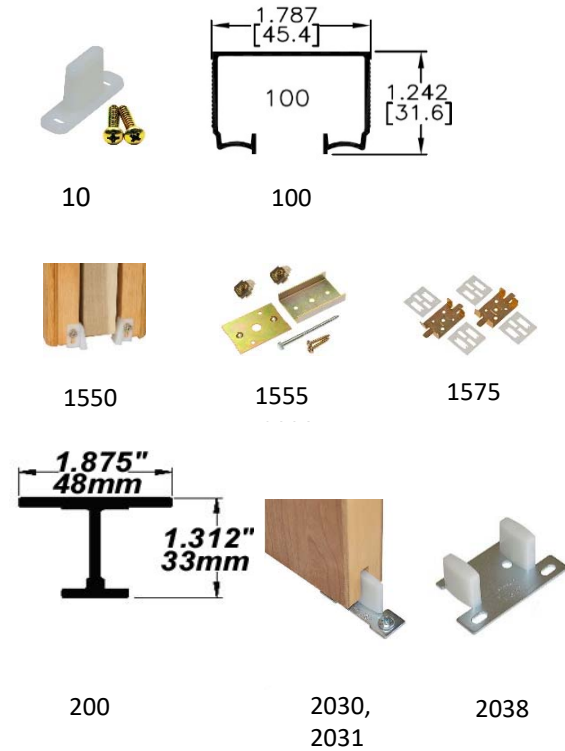

Bifold kits include Track, Hangers and Pivots. Hinges sold separately

<u>Item</u>	Bifold Kit 1825 doors to 35 lbs. each	List
1825-24	2-Drs for opening 24"	20.00
1825-30	2-Drs for opening 30"	20.00
1825-32	2-Drs for opening 32"	21.00
1825-36	2-Drs for opening 36"	21.00
1825-48	4-Drs for opening 48"	40.00
1825-60	4-Drs for opening 60"	40.00
1825-72	4-Drs for opening 72"	42.00
1825-84	4-Drs for opening 84"	45.00
1825-96	4-Drs for opening 96"	51.00

Finish Height = Door Ht+1-3/4
1-1/8" to 1-3/4" doors
to 35 lbs. each (7/16"
pivot hole).

No Height Adjustability

Finish opg W 2xDr width + 9/16"

Finish opg W 4xDr width + 11/16"

<u>Item</u>	Bifold Kit BF50 doors to 50 lbs. each	List
Kit.BF50.24	2-Drs for opening 24"	46.50
Kit.BF50.30	2-Drs for opening 30"	46.50
Kit.BF50.36	2-Drs for opening 36"	46.50
Kit.BF50.48	4-Drs for opening 48"	70.70
Kit.BF50.60	4-Drs for opening 60"	74.80
Kit.BF50.72	4-Drs for opening 72"	80.00
Kit.BF50.96	4-Drs for opening 96"	91.20

Finish Height = Door Ht+2-3/8"

Door thickness 1" to 1-3/4"

doors to 50 lbs. each with 2 dr to a
jamb. Weight to 30 lb if using more
than 2 doors to a jamb

<u>Item</u>	Bifold Kit BF125 doors to 125 lbs. each	List
Kit.BF125.24	2-Drs for opening 24"	58.20
Kit.BF125.30	2-Drs for opening 30"	59.90
Kit.BF125.36	2-Drs for opening 36"	61.50
Kit.BF125.48	4-Drs for opening 48"	116.00
Kit.BF125.60	4-Drs for opening 60"	119.60
Kit.BF125.72	4-Drs for opening 72"	122.90
Kit.BF125.96	4-Drs for opening 96"	135.50

Finish Height = Door Ht+2-7/8"

Door thickness 1" to 1-3/4" with weight to
lbs. each with 2 dr to a jamb. Weight to 75
per door if using more than 2 doors to a ja

Multi-Fold Hardware		List
<u>200RD Weight: 75 lbs. each, Max Size: 3'x9' (hinges extra)</u>		
2015BS-A	Basic Set A	118.00
2002PLBG	Addon set B	62.00
200-8 Track	96" long	117.00

Door Thickness: 1-1/8" to 1-3/4".

Max Door Weight: 75 lbs. ea. Max

Dr Size: 36" x 108"

Order Ball Bearing 3-1/2" hinges

<u>100RD Weight: 50 lbs. each, Max Size: 2'x9' (includes hinges)</u>		List
1015BS-A	Basic Set	84.00
1030AOSB	Add on Set B	83.00
100-8 Track	96" long	68.00

Door Thickness: 1" to 1-3/4". Max

Door Weight: 50 lbs. ea. Max Dr

Size: 24" x 108"

Bifold Door Parts

<u>Parts used across all series</u>		List
BF1805	Hinges (price per pair)	4.34
BF1808 or BF50-72	pr 4-Dr Aligner (1 set)	2.20
BF50-36	Birch Knob Each 1-3/4" diam.	1.00
BF50-60.WH	White Plastic Knob Each 1-3/4" diam.	0.60
BF50-60.BRN	Brown Plastic Knob Each 1-3/4" diam.	0.60
BF50-60.TAN	Tan Plastic Knob Each 1-3/4" diam.	0.60
BF1705	Guide Roller for BF1050 Each	1.60
BF1050	Bottom Guide Channel-8' Each	20.60



<u>Bifold BF125N Parts</u>		List
BF125N-01-48	48" Track	17.90
BF125N-01-60	60" Track	21.40
BF125N-01-72	72" Track	24.50
BF125N-01-96	96" Track	36.90
BF125-21	2-Dr Snugger	2.20
BF125N-51	1-Hanger & 1-Pivot	48.70

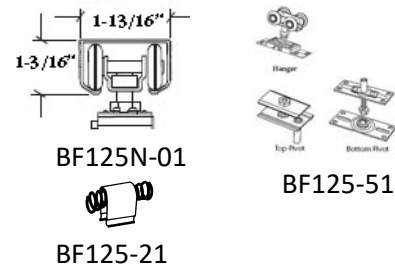

<u>Bifold BF50 Parts</u>		List
BF50-01-48	48" Track	22.00
BF50-01-60	60" Track	26.00
BF50-01-72	72" Track	31.00
BF50-01-96	96" Track	42.00
BF50-HDW	Pivot Set	11.00
BF50-11	Top Pivot Bracket	3.00
BF50-22	2-Door Snugger	1.00
BF50-24	4-Door Snugger	1.00
BF50-33	Bottom Pivot	2.00
BF50-34	Top Pivot	2.00
BF50-41	Hanger - 2 wheel & guide wheel	13.00
BF50-81	Jamb Bracket	2.00
BF50-299	Wrench	1.00

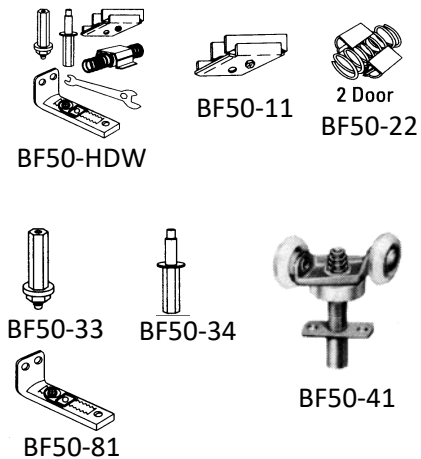

<u>1825 Series Parts</u>		List
BF1801	Top Pivot Guide	2.10
BF1804	Bottom Pivot Bracket	3.90
BF1807	Bottom Pivot	2.10
BF1810	Top pivot bracket	2.80
BF1811	Bottom Pivot Jamb Bracket	2.90
BF1836	Carpet Riser for use with 1811	2.60
BF1861	Bottom Pivot Jamb Bracket	1.80
1712	Wrench	0.80

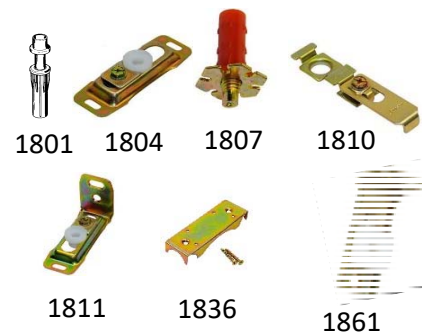

Bypass Hardware Sets

For doors to 50 lbs each. 3/4" or 1-3/8" thick doors.

Steel Gold Track - No Fascia	Description	List
1166-48	For Two 2'0" Doors	27.00
1166-60	For Two 2'6" Doors	31.40
1166-72	For Two 3'0" Doors	35.70
1166-96	For Four 2'0" Doors	68.50
Aluminum Track - No Fascia	Description	List
2200-48	For Two 2'0" Doors	31.00
2200-60	For Two 2'6" Doors	36.00
2200-72	For Two 3'0" Doors	40.00
2200-96	For Four 2'0" Doors	70.00

Finished Opening Height: Door + 1-3/4".

Upgrade to 75lb with purchase 2- 2228

Finished Opening Height: Door + 1-3/4".

Upgrade to 75 lb with purchase 2- 2228

For doors to 75 lbs each. 1-3/8" thick doors.

Aluminum Track with Fascia	Description	List
2200F-48	For Two 2'0" Doors	38.00
2200F-60	For Two 2'6" Doors	45.00
2200F-72	For Two 3'0" Doors	51.00
2200F-96	For Four 2'0" Doors	87.00

Finished Opening Height: Door + 1-3/4".

For doors to 125 lbs each. 1-3/4" thick doors.

Aluminum Track with Fascia	Description	List
134F-48	For Two 2'0" Doors	103.00
134F-60	For Two 2'6" Doors	116.00
134F-72	For Two 3'0" Doors	128.00
134F-96	For Four 2'0" Doors	210.00

Finished Opening Height: Door + 2-3/8".

Upgrade to 200lb with purchase 2- 1125

For 1-3/8" to 2-1/4" thick doors. Track is made up of 2 pieces

150 Lbs. Aluminum Track	Description	List
Kit.BP150-48	For Two 2'0" Doors	87.20
Kit.BP150-60	For Two 2'6" Doors	94.50
Kit.BP150-72	For Two 3'0" Doors	101.10
Kit.BP150-96	For Two 4'0" Doors	126.20
250 Lbs. Aluminum Track	Description	List
Kit.BP250-48	For Two 2'0" Doors	103.80
Kit.BP250-60	For Two 2'6" Doors	111.10
Kit.BP250-72	For Two 3'0" Doors	117.70
Kit.BP250-96	For Two 4'0" Doors	142.80

Finished Opening Height: Door + 2-5/8".

Finished Opening Height: Door + 2-5/8".

[Plastic Bypass Track for Plywood Panels](#)

Item	Description	List
M14.48	For 1/4": Two 2'0" Panels	7.40
M14.72	For 1/4": Two 3'0" Panels	9.30
M14.96	For 1/4": Two 4'0" Panels	13.90
M12.48	For 1/2": Two 2'0" Panels	11.00
M12.72	For 1/2": Two 3'0" Panels	13.70
M12.96	For 1/2": Two 4'0" Panels	20.40
M34.48	For 3/4": Two 2'0" Panels	14.10
M34.72	For 3/4": Two 3'0" Panels	18.20
M34.96	For 3/4": Two 4'0" Panels	24.40



Bypass Door Parts

Bypass Parts	Description	List
1120	Hanger Ea. for (134F & 1530)	8.80
1121	Hanger Plate for 1120/1125	2.90
1125	Hanger Ea. 200 lb (134F&1560)	17.00
2030	Guide Post Each. 1.21"H	4.60
2034	1-3/4" Bypass Door guide	9.30
2035	1-3/8" Bypass Door guide	9.40
2054	Multi-Pass Pull per Set	15.40
2135	Bypass Guide 3/4" or 1-3/8"	2.00
2136	Carpet Riser 5/8" High	2.60
2155	Door Stop Mounts on door	1.80
2165	Track Stop 1166, 1138, 2200, 2200F	3.30
2216	Hanger ea. 1/16" offset (1166 - 2200)	2.10
2228	Hanger ea. 75lb (2200-2200F)	4.10
2238	Hanger ea. 3/8" offset (1166 - 2200)	2.20
2312 (old PD75)	Hanger ea. V- track & 7/8" Wheel	10.30
BP150-71	Floor Guide for 1-3/8" drs.	2.80
BP150-73	Nylon Floor Guide, per pair	1.90
BP 150N-HDW	Bag 150 lb (2 pr hangers, guide)	47.10
BP 250N-HDW	Bag 250 lb (2 pr hangers, guide)	63.70
BP250N-01-48	Track Each - 2 req'd per opg	17.90
BP250N-01-60	Track Each - 2 req'd per opg	21.40
BP250N-01-72	Track Each - 2 req'd per opg	24.50
BP250N-01-96	Track Each - 2 req'd per opg	36.90
BP250N-01-120	Track 10'	47.40
BP250N-01-144	Track 12'	56.90
BP250N-01-192	Track 16'	94.60
BP250-71	Floor Guide ADJ for 1-3/8" to 1-	9.80
BP250-77	Center Stop for BP250-01 track	2.00
BP250-99	Wrench	1.00
TR250	1-3/4" Spacer for BP250, ea.	2.40

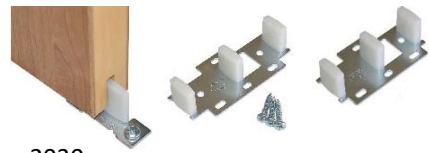

2030 2034 2035



2054 2135 2136



2155 2165



BP150-71 BP150-73



BP250-71 BP250-77



BP250-99 TR250



1120 1125 2020



2216 2238 2228 2312



BP150N-HDW
BP250N-HDW BP250-71



[B4825](#)

[B4820](#)

Door Viewers	B4825	B4820
	List	List
	180°	160°
Bright Brass	17.80	4.60
Antique Brass	21.00	-
Oil Rubbed Bronze	17.80	-
Bright Nickel	21.00	9.20
Satin Nickel	17.80	-



[4230](#)

[7305](#)

Coat Hooks	4230	7305
	List	List
	3"	5"
Bright Brass	1.90	8.00
Antique Brass	2.80	
Oil Rub Brz / Black	3.70	10.00
Satin Nickel	2.80	
Pewter/Satin Bronze	2.70	-
Nickel	-	8.00
Satin Chrome	2.70	-

Mail Plates

	L626 List	L627 List	L620 List	L212 List	L30 List	L158 List	L601 List
Bright Brass	103.00	128.00	118.00	185.00	252.00	78.00	-
Antique Brass	106.00	131.00	121.00	193.00	259.00	84.00	-
Oil Rub Bronze	106.00	131.00	121.00	193.00	259.00	84.00	-
Aged Bronze	-	-	130.00	-	-	-	-
Satin Nickel	106.00	131.00	121.00	193.00	259.00	84.00	-
Pewter	106.00	131.00	121.00	193.00	259.00	84.00	-
Black	106.00	131.00	121.00	193.00	259.00	84.00	-
Bright Chrome	106.00	131.00	121.00	193.00	259.00	84.00	-
Satin Chrome	106.00	131.00	121.00	193.00	259.00	84.00	-
Stainless Steel	-	-	-	-	-	-	42.00



L30



L212



L620



L626



L627

L626 - Spring loaded front plate and standard back plate.
Plate Opening: 7" x 1-1/2". Overall 8-7/8" x 2-7/8".

L627 - Spring loaded front plate and gravity back plate.
Plate Opening: 7" x 1-1/2". Overall 8-7/8" x 2-7/8".

L620 - Spring loaded front plate and standard back plate
Plate Opening 11" x 2". Overall 13" x 3-9/16".

L212 - Spring loaded front plate and covered back plate.
Plate Opening 11" x 2".. Overall 13" x 3-9/16".

L30 - Front plate assembly and standard back plate
Plate Opening 11 x 2". Overall 13" x 3-1/16".



L158 Hood for 1-3/4" Doors
use with L30
12-3/4" x 3-1/4"



L601 Sleeve for 1-3/4" Doors
use with L620,L212,L30

Full Lip	Size	Bright Brass List	Ant Brass List	Satin Nick List	Pewter List	Stain Steel List	Dark Brz List
EL115	2 1/4" X 1 1/2"	11.00	15.00	15.00	17.00	10.00	17.00
EL175	2 1/4" X 1 3/4"	11.00	15.00	15.00	17.00	10.00	17.00
EL102	2 1/4" X 2"	11.00	15.00	15.00	17.00	10.00	17.00
EL125	2 1/4" X 2 1/2"	11.00	15.00	15.00	17.00	10.00	17.00
EL103	2 1/4" X 3"	11.00	15.00	15.00	17.00	10.00	17.00
EL104	2 1/4" X 4"	24.00	30.00	30.00	32.00	22.00	28.00

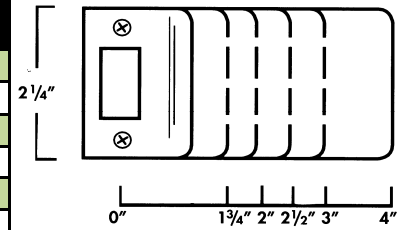

Full Lip	Size	Bright Brass List	Silver List	Dark Brz List
EL202	2 3/4" X 2"	16.00	16.00	16.00
EL225	2 3/4" X 2 1/2"	16.00	17.00	17.00
EL203	2 3/4" X 3"	16.00	17.00	17.00
EL204	2 3/4" X 4"	20.00	21.00	21.00
EL205	2 3/4" X 5"	20.00	21.00	21.00

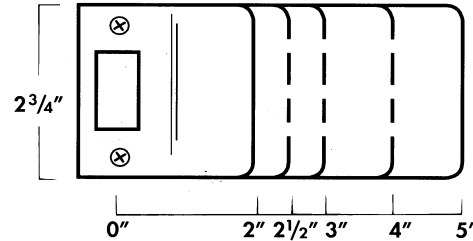

ANSI Strike	Size	Stain Steel List	Dark Brz List
EST175	4-7/8" X 1 3/4"	29.00	34.00
EST102	4-7/8" X 2"	29.00	34.00
EST125	4-7/8" X 2 1/2"	29.00	34.00
EST103	4-7/8" X 3"	29.00	34.00
EST104	4-7/8" X 4"	36.00	41.00

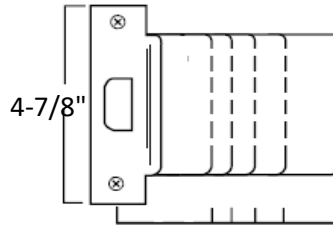

T-Strike	Size	Bright Brass List	Ant. Brass List	Stain Steel List	Dark Brz List
ETS102	2 3/4" X 2"	16.00	21.00	16.00	20.00
ETS125	2 3/4" X 2 1/2"	16.00	21.00	16.00	20.00
ETS103	2 3/4" X 3"	16.00	21.00	16.00	20.00
ETS104	2 3/4" X 4"	23.00	33.00	23.00	28.00
ETS175	2 3/4" X 1 3/4"	16.00	21.00	16.00	20.00

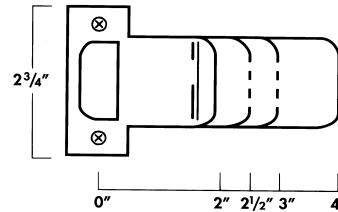

<u>Thimble Strike</u>		Brass List	Chrome List
TS1000	1" Diameter	6.10	6.10



Hole Filler Plate		Brass List	Prime List	Chrome List
BF161	Up to 2-1/2"	13.00	7.00	10.00

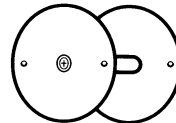

ANSI Filler Strike		Prime List
FS260	4-7/8" X 1-1/4"	3.50

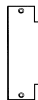

86 Mortise Filler Plate		Prime List
CV86	8" X 1-1/4"	13.20
CV8624	8" X 1-1/4"	27.20

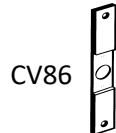

CV8624 bores are 4" on center

Latch & Hinge Filler Plate		Brass List	Prime List
EF160	1" x 2-1/4"	11.70	4.00
EF161	1-1/8" x 2-1/4"	11.70	4.00
FF45	4-1/2" x 1-5/8"	-	4.30



[Table of Contents](#)

[Latch Protectors](#)

Item	Description	Silver List	Brass List
PLP211	Pin Latch Protector for Outswing	22.00	-
CLP110	Commercial for Outswing	37.00	-
NLP210	Narrow Commercial for Outswing	33.00	-
DR10	Edge Reinforcer 1-3/8" Door	17.00	24.00
DR20	Edge Reinforcer 1-3/4" Door	17.00	24.00



3" x 11"
PLP211



2-1/8" x 10"
CLP110



1-1/2" x 10"
NLP210



DR10 for 1-3/8" Doors



DR20 for 1-3/4" Doors

Height: 4-1/2"

CTR to CTR screws: 1-5/8"

Latch hole: 7/8" wide

Side Projection: 1"

Door Reinforcers

Item	Backset	Door	Size	Material				
				Brass List	Antique Brass List	Satin Brz List	Oil Rub Bronze List	Stainless Steel List
1	2-3/8"	1-3/8"	4" x 9"	44.00	63.00	63.00	58.00	37.00
2	2-3/8"	1-3/4"	4" x 9"	41.00	59.00	59.00	54.00	35.00
3	2-3/4"	1-3/8"	4 1/4" x 9"	44.00	63.00	63.00	54.00	37.00
4	2-3/4"	1-3/4"	4 1/4" x 9"	41.00	59.00	59.00	54.00	35.00
5	2-3/8"	1-3/8"	4" x 4 1/2"	30.00	50.00	50.00	43.00	25.00
6	2-3/8"	1-3/4"	4" x 4 1/2"	29.00	47.00	47.00	43.00	23.00
7	2-3/4"	1-3/8"	4 1/4" x 4 1/2"	30.00	50.00	50.00	43.00	25.00
8	2-3/4"	1-3/4"	4 1/4" x 4 1/2"	29.00	47.00	47.00	43.00	23.00
51	2-3/8"	1-3/8"	4" x 4 1/2"	30.00	50.00	50.00	43.00	25.00
61	2-3/8"	1-3/4"	4" x 4 1/2"	29.00	47.00	47.00	43.00	23.00
71	2-3/4"	1-3/8"	4 1/4" x 4 1/2"	30.00	50.00	50.00	43.00	25.00
81	2-3/4"	1-3/4"	4 1/4" x 4 1/2"	29.00	47.00	47.00	43.00	23.00
151	2-3/8"	1-3/8"	4" x 9"	44.00	63.00	63.00	54.00	37.00
261	2-3/8"	1-3/4"	4" x 9"	41.00	59.00	59.00	54.00	35.00
481	2-3/4"	1-3/4"	4 1/4" x 9"	44.00	59.00	59.00	54.00	35.00
256	2-3/8"	1-3/4"	4" x 12"	54.00	66.00	66.00	65.00	50.00
258	2-3/4"	1-3/4"	4 1/4" x 12"	58.00	66.00	66.00	65.00	50.00
154	2-3/8"	1-3/8"	4" x 9"	41.00	59.00	59.00	54.00	35.00
264	2-3/8"	1-3/4"	4" x 9"	44.00	59.00	59.00	54.00	35.00
484	2-3/4"	1-3/4"	4 1/4" x 9"	41.00	59.00	59.00	54.00	35.00



DR1
DR2
DR3
DR4



DR5
DR6
DR7
DR8



DR51
DR61
DR71
DR81



DR154
DR264
DR484
4" OC





DR151
DR261
DR481
3-5/8" OC

DR256
DR258
5-1/2" OC

Window Hardware

						
	Sash Locks	Sash Locks Solid Brass	Sash Lifts	Sash Lifts Solid Brass	Hanger V80 Sold per Pair	Latch V83 Sold Set of 4
	07A List	07B List	026A List	026B List	V80 List	V83 List
Bright Brass	3.70	23.00	3.00	12.00	-	-
Antique Brass	5.70	-	5.00	-	-	-
Aged Bronze	-	29.00	5.00	15.00	-	-
Satin Nickel	4.70	33.00	-	15.00	-	-
Pewter	-	35.00	-	18.00	-	-
Black	-	31.00	5.00	-	-	-
Bright Chrome	-	32.00	4.00	12.00	-	-
Sat Chrome	-	32.00	-	17.00	-	-
Galvanized	-	-	-	-	10.10	8.10













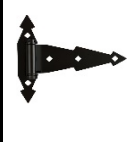
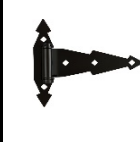

				
	Casement Latch	Casement Latch Solid Brass	Transom Catch	Tansom Chain 12"
	066A List	066B List	80B List	82 List
Bright Brass	9.00	38.00	71.00	11.00
Antique Brass	-	46.00	-	-
Oil Rub Bronze	9.00	-	71.00	-
Satin Nickel	-	48.00	71.00	13.00
Pewter	-	-	-	-
Black	-	-	71.00	-
Bright Chrome	9.00	46.00	-	-
Sat Chrome	-	46.00	-	-

[Table of Contents](#)

[Closers](#)

[Screen and Gate Hardware](#)

[See Kit Pricing](#)

								
	Half/Full Surface	Mortise Hinge	Half Surface	Full Surface Spring	Adj. Spring Hinge	NON-Adj. Spring Hinge	Chain Door Stop	Door Spring 16"
Finish	V129 List	V513 List	3035 List	2960 List	966S List	968S List	45S List	V76 List
Dull Brass	15.00	-	-	23.00	-	-	-	-
Bright Brass	-	56.00	76.00	-	-	-	-	-
Lifetime Brass	-	0.00	84.00	-	-	-	-	-
Ant Brass	-	0.00	84.00	-	-	-	-	-
Oil Rub Brz	-	64.00	84.00	-	-	-	-	-
Satin Nickel	-	64.00	84.00	-	-	-	-	-
Pewter	-	0.00	84.00	-	-	-	-	-
Black	15.00	64.00	76.00	23.00	44.00	26.00	7.00	-
Brite Chrome	-	0.00	84.00	-	-	-	-	-
Sat Chrome	-	0.00	84.00	-	-	-	-	-
Galvanized	29.00	-	-	-	-	-	-	-
Zinc	12.00	-	-	23.00	-	-	7.00	6.00
								
	Tubular	Knob Only	Mortise	Mortise	Ornamental	Ornamental	7" Handle	5" Handle
Finish	1159 List	1100 List	1190 List	1191 List	1165 List	C103S List	C110S List	P25 List
Bright Brass	60.00	27.00	210.00	210.00	-	-	-	3.00
Ant Brass	63.00	-	210.00	210.00	-	-	-	-
Oil Rub Bronze	63.00	-	210.00	210.00	-	-	-	-
Satin Nickel	63.00	-	210.00	210.00	-	-	-	-
Pewter	63.00	-	210.00	210.00	-	-	-	-
Black	60.00	27.00	210.00	210.00	41.00	31.00	10.00	4.00
Pol. Chrome	63.00	-	210.00	210.00	-	-	-	-
Satin Chrome	63.00	-	210.00	210.00	-	-	-	-
Aluminum	-	-	-	-	-	-	-	3.00

Kit 1159 K-1	Black	
1-#1159 Black Storm Door Lock	60.00	
1-#V1342 Black Door Closer	29.00	
2-Strap Hinges 13-1/4"	31.00	
1-Strap Hinge 9"	27.00	
1-#45s Chain Door Protector Black	7.00	
Component Total	154.00	
List when buying 1159K1	\$147	
Kit 1159 V	Brass or Black	Other
1-#1159 Storm Lock	60.00	63.00
1-#V1342 Door Closer	29.00	29.00
1-1/2 pair V129 Hinges Galvanized	29.00	29.00
1-#45s Chain Door Protector Black or Zinc	7.00	7.00
Component Total	125.00	128.00
List when buying 1159V	\$119	\$122
Kit 1165K-1	Black	
1-#1165 Black Thumb Latch Set	41.00	
1-#V1342 Black Door Closer	29.00	
2-Strap Hinges 13-1/4"	31.00	
1-Strap Hinge 9"	27.00	
1-#45s Chain Door Protector Black	7.00	
Component Total	135.00	
List when buying 1165K1	\$129	
Kit 1159SB	Brass or Black	Other
1-#1159 Storm Lock	60.00	63.00
1-#SN123 Door Closer	75.00	75.00
1-1/2 pair 3035 matching SOLID brass Hinges	76.00	84.00
1-#45s Chain Door Protector Black or Zinc	7.00	7.00
Component Total	218.00	229.00
List when buying 1159SB	\$208	\$218
Kit 1190/1191	All Finishes	
1-1190	210.00	
1-#SN123 Door Closer Black or Silver	75.00	
1-1/2 pair 3035 matching SOLID brass Hinges	84.00	
1-#45s Chain Door Protector Black or Zinc	7.00	
Component Total	376.00	
List when buying 1190/1191	\$358	

[Table of Contents](#)

[Clavos](#)

Item	Description	List
CL34R	3/4" Round	3.50
CL118R	1-1/8" Round	4.10
CL158R	1-5/8" Round	4.70
CL1P	1" Pyramid	4.10
CL158P	1-5/8" Pyramid	4.70
CL118S	1-1/8" Square	4.70
CL158S	1-5/8" Square	4.70
Adhesive Back		
CL114RAD	1-1/4" Round	18.40
CL112RAD	1-1/2" Round	18.40
CL114PAD	1-1/4" Pyramid	18.40
CL112PAD	1-1/2" Pyramid	18.40

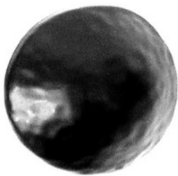

Round

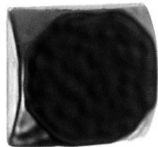

Square



Pyramid

Wire Shelving & Accessories

Shelving and accessories are stock.

Item	Shelf & Rod 12'	Per Ctn.	List Each
1110-1212	12" Shelf & Rod	6	63.20
1110-1612	16" Shelf & Rod	6	91.50
	Open Slide 12'		List Each
1710-1212	12" Open Slide Shelf	6	99.40
1710-1612	16" Open Slide Shelf	4	132.70
	Storage (Linen) 12'		List Each
1210-1212	12" Linen Shelf	6	57.70
1210-1612	16" Linen Shelf	6	79.40
1210-2012	20" Linen Shelf	6	111.30
	Tight Mesh 12'		List Each
1510-1212	12" Tight Mesh Shelf	6	82.80
1510-1612	16" Tight Mesh Shelf	6	110.50
1510-2012	20" Tight Mesh Shelf	6	142.10

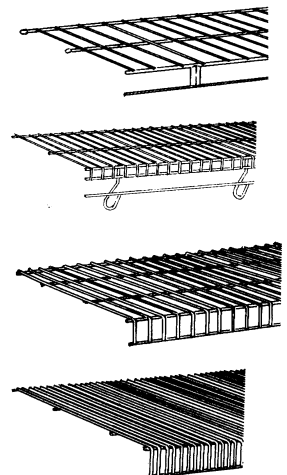

Item	Corner Shelves	Per Ctn.	List Each
1110-1219	12" Shelf & Rod Corner	10	62.50
1110-1619	16" Shelf & Rod Corner -subject to stock	10	35.70
1710-1219	12" Open Slide Corner	10	62.90
1710-1619	16" Open Slide Corner	10	71.70
	<u>Basic Installation Hardware</u>	Per Ctn.	List Each
1430-6743	Pin Driven Back Clip (install every 11")	3000	0.43
1430-6620	Versa Back Clip with Tri-Loc II	2000	0.44
1430-6753	Pin Driven Wall Anchor	3000	0.36
1430-6623	Tri Loc II Anchor	1000	0.50
1430-6725	Pin Driven Wall Bracket	500	1.51
1430-6621	Wall Bracket with Tri-LocII	300	1.25
1430-6624	Wall Bracket - No anchors	300	0.80
1435-6646	Angled Side Wall Bracket (rotates to 45 degrees)	10	5.80
1435-6645	1/4" Strap Back Clip	100	0.40

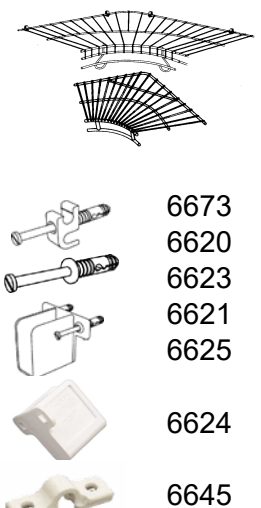

- 6673
- 6620
- 6623
- 6621
- 6625
- 6624
- 6645

Item	Supports	Per Ctn.	List Each
1435-6658	9" Tight-Mesh and 10" Shelf&Rod	30	3.30
1430-6659	12" Shelves, 16" Shelf & Rod & 16" Open-Slide	100	2.88
1435-6661	16" Linen and Tight-Mesh and as a ctr support for 20" Tight-Mesh	30	3.60
1465-6663	20" Standard and Tight-Mesh Storage Shelves	30	4.10
1430-6635	12" Joiner Support Brace (requires 2-6677) - subject to stock	100	2.20
1435-6637	16" Joiner Support Brace (requires 2-6677) - subject to stock	10	2.70



	Joiner Clamps	Per Ctn.	List Each
1430-6677	Joiner Clamp : Use 2 per Brace; Order 6687 & 6689 screw & nut	100	1.00
1430-6687	#8-32 Pan Head Phillips Machine Screw	1000	0.08
1430-6689	#8-32 Nut	1000	0.08
1435-6676	Open-Slide Joiner Clip, nuts, bolts, WasteSaver Joiners	10 sets	1.90



6677

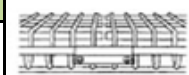

6676

Item	Support Pole & Hardware	Per Ctn.	List Each
1430-6665	Adjustable Pole Clip Plastic w/ screw	100	1.20
1430-6670	Snap-in Pole Clip	100	1.95
1430-6671	Base Cap	100	0.30
1430-6673	Vertical support pole 84-3/4"	24	14.80



Item	End Cap, Corner Bracket, Shoe Support	Per Ctn.	List Each
1430-6675	Metal Corner Bracket	100	2.30
1430-6681	#8x1-1/2" Truss Phillips Screw use with support braces	1000	0.18
1435-6688	#8X1-1/2" Phillips Screw for sidewall brk	250	0.18
1435-6652	Double End Cap (replaces 6651)	200	0.45
1430-6697	F-Channel; 6' Plastic Sidewall support for angled walls.	12	48.90
1430-6699	Extra Small End Cap for Crosswires	1000	0.06
1430-6693	Medium End Cap-for all styles except tight mesh (old 6683,6684)	1000	0.06
1430-6694	Large End Cap-for all styles except tight mesh (old 6685,6686)	1000	0.06
1430-6668	Shoe Shelf Support - Used with linen & tight mesh	100	1.90



6675



6652



6697



6668

Item	Closet Rods	Per Ctn	List
7913-1524	2' Chrome Rod	8	8.00
7913-1536	3' Chrome Rod	8	12.00
7913-1548	4' Chrome Rod	8	16.00
7913-1572	6' Chrome Rod	8	24.00
7913-1596	8' Chrome Rod	8	32.00
7913-1510	Rod Stops (pair)	12	8.00
6745-1511	Rod Install Flange		3.00



Item	Adjustable Rods	Ctn	List
4500 18-30	Expands 18"-30"	10	9.00
4500 30-48	Expands 30"-48"	10	12.00
4500 48-72	Expands 48"-72"	10	19.00
4500 72-96	Expands 72"-96"	10	24.00
4500 72-120	Expands 72"-120"	10	31.00
4500 96-150	Expands 96"-150"	10	38.00
Item	Shelf & Rod Support	Ctn	List
4700	White: 10-1/4 to 10-3/4	20	5.50

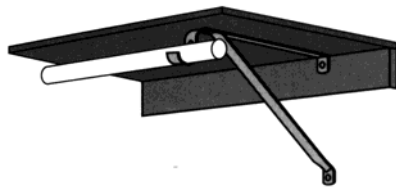
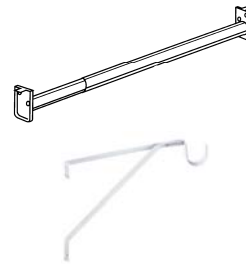

Barn Door Hardware - Exterior

ITEM	DESCRIPTION	List
BD301-8	Galvzd Track 8'	59.00
BD301-10	Galvzd Track 10'	74.00
BD301-12	Galvzd Track 12'	89.00
BD32LB	Hangers (pair)	83.00
BD1-301	Single Side Bracket	10.00
BD1L-301	Joint Bracket - Splice bracket will join 2 pcs track	11.00
BD3-301	Ceiling Bracket	9.00
BD5-301	Double Side Bracket	32.00
BD301EC	End Cap Only (fits inside Brackets sold separately)	2.00
BD65	Door Holder/stop - Max dr 2-1/4"	11.00
BD67	Stake Holder 7-3/4"w x 2-1/2"h	12.00
BD79	Guide -Adjust to 3-1/4"	48.00
BD92	Stay Roll - Adjust for 1-1/2" to 2-1/2" doors	16.00
BD95	Stay Roll - Adjusts for 1-1/4" to 2-5/8" doors	12.00
BD96	Stay Roll - Adjusts for 1" to 3-3/4" doors	27.00
*BD98	Stay Roll with 6" Lag - Close Out	7.00
BD120	Jamb Latch 7". Door thick 1-1/2" and greater	19.00
BD124	Sliding Latch Zinc. Accepts a padlock.	22.00
BD208	Door Pull - 7-7/8" Zinc	7.00

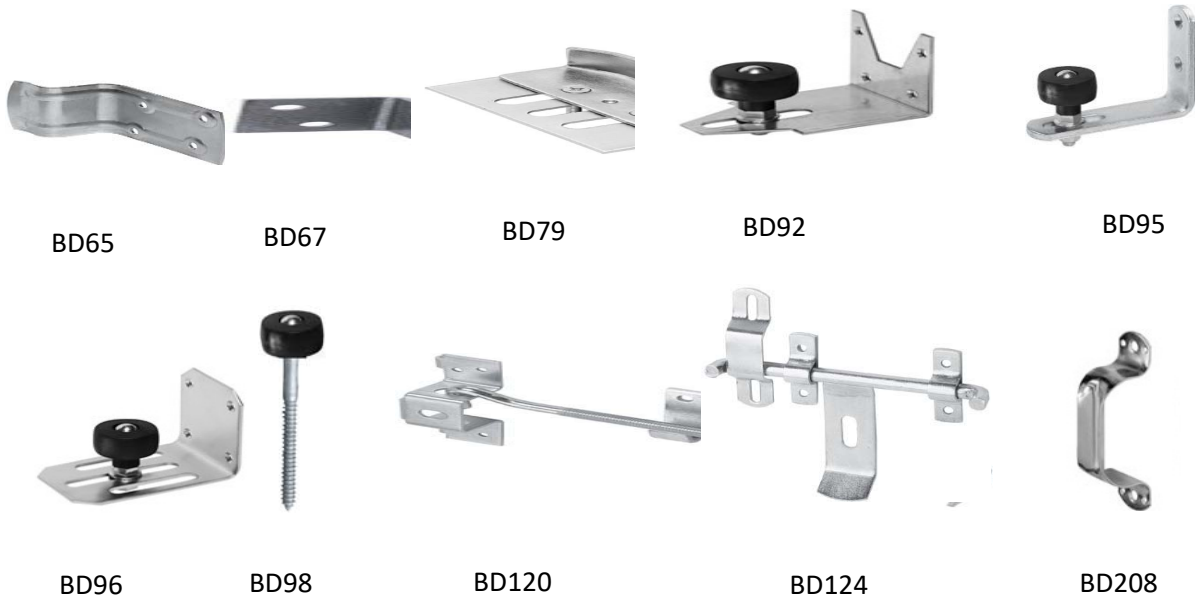
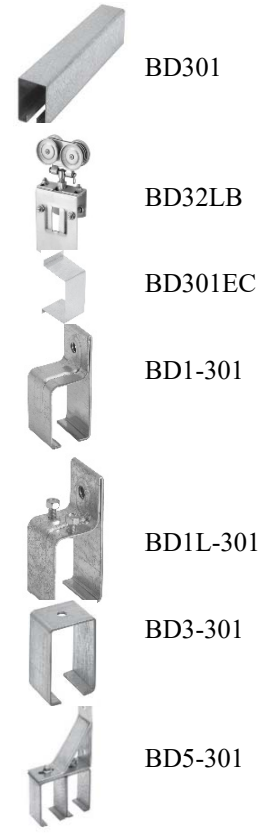

[Barn Door Hardware - Flat Track Designer](#)

6' Kits	For weights up to 220 lbs	List
MFS3-6.622	Kit 6.6 ft. Hook Strap Wheel 2-3/4 Black	210.00
MFS3-6.WHT	Kit 6.6 ft. Hook Strap Wheel 2-3/4 White	Call
MFS3-6.619	Kit 6.6 ft. Hook Strap Wheel 2-3/4 Sat. Nickel	354.00
MFS3-6.609	Kit 6.6 ft. Hook Strap Wheel 2-3/4 Ant. Brass	Call
MFS3-6.625	Kit 6.6 ft. Hook Strap Wheel 2-3/4 Chrome	Call
MFS3-6.606	Kit 6.6 ft. Hook Strap Wheel 2-3/4 Satin Brass	Call
MFS3-6.613	Kit 6.6 ft. Hook Strap Wheel 2-3/4 Satin ORB	Call
MFS5-6.622	Kit 6.6 ft. Hook Strap Wheel 5" Black	115.00
MFSTM-6	Kit 6.6 ft. Top Mount Wheel 2-3/4 Black (up to 198 lb)	Call
Parts	Designer Parts	List
Floor.Guide.1403.622	Floor Guide for Wood Doors-Plastic Black	3.00
MFS.19.622	Rail Connector works with MFS Track, Black	9.00
MFS.23.622	By-pass Bracket Each. Black. Ord 5 for 6'6 track	22.00
MFS.24.622	Soft-close MFS (pair) (N/A w/Chrome). Black.	74.00



MFS3



MFS5



MFSTM



MFS19



MFS23

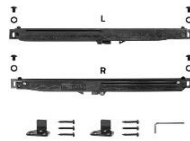

MFS24

Barn Door Hardware - Flat Track "R-Series"

4' Kits	Rated for up to 250 lbs	List
Kit.RSS.4	Kit 4' with 3" Hook Strap Black	224.00
Kit.RSB.4	Kit 4' with 5" Hook Strap Black	251.00
Kit.RSR.4	Kit 4' with Stick Strap Black	215.00
6' Kits		List
Kit.RSS.6	Kit 6' with 3" Hook Strap Black	246.00
Kit.RSB.6	Kit 6' with 5" Hook Strap Black	272.00
Kit.RSR.6	Kit 6' with Stick Strap Black	237.00
8' Kits		List
Kit.RSS.8	Kit 8' with 3" Hook Strap Black	542.00
Kit.RSB.8	Kit 8' with 5" Hook Strap Black	576.00
Kit.RSR.8	Kit 8' with Stick Strap Black	531.00

Parts		List
Strap.RSS	Hanger Each Only 3" Hook	60.00
Strap.RSB	Hanger Each Only 5" Hook	73.00
Strap.RSR	Hanger Each Only Round Stick	55.00
FT.Track..4	Flat Rail 4 ft Black USA	57.00
FT.Track..6	Flat Rail 6 ft BlackUSA	71.00
FT.Track..8	Flat Rail 8 ft Black USA	236.00
FT.Splice.622	Splice Kit for Flat Rail USA Black	14.00
FT.R201 Bracket	Flat Rail Bracket Kit Black	8.00
FT.R40 Stop	Flat Rail Stop Kit Black	15.00
Floor.Guide.1403.622	Black Plastic Floor Guide Wood Door	3.00



RSS



RSB



RSR



[Barn Door Hardware - Round Track](#)

		Black	Oil Rub Brz	Satin Nickel
4' Kits	Rated for 250 lbs for 1-1/4" to 2-1/4" Doors	List Black	List ORB	List 619
Kit.RT4.Fleur	4' Fleur-de-Lis Round Track Hammered	518.00	569.80	-
Kit.RT4.Hook	4' Hook Round Track	361.00	397.10	397.10
Kit.RT4.HS	4' Horseshoe Round Track	377.00	414.70	414.70
Kit.RT4.Round	4' Round Stick Round Track	341.00	375.10	375.10
Kit.RT4.Spade	4' Spade Round Track Hammered	510.00	561.00	-
Kit.RT4.Square	4' Square Stick Round Track	345.00	379.50	379.50
Kit.RT4.Three	4' Three Point Round Track	393.00	432.30	432.30
Kit.RT4.TM	4' Top Mount Round Track	345.00	379.50	379.50
6' Kits		List Black	List ORB	List 619
Kit.RT6.Fleur	6' Fleur-de-Lis Round Track Hammered	574.00	631.40	-
Kit.RT6.Hook	6' Hook Round Track	417.00	458.70	458.70
Kit.RT6.HS	6' Horseshoe Round Track	433.00	476.30	476.30
Kit.RT6.Round	6' Round Stick Round Track	397.00	436.70	436.70
Kit.RT6.Spade	6' Spade Round Track Hammered	566.00	622.60	-
Kit.RT6.Square	6' Square Stick Round Track	401.00	441.10	441.10
Kit.RT6.Three	6' Three Point Round Track	449.00	493.90	493.90
Kit.RT6.TM	6' Top Mount Round Track	401.00	441.10	441.10
8' Kits		List Black	List ORB	List 619
Kit.RT8.Fleur	8' Fleur-de-Lis Round Track Hammered	756.00	831.60	-
Kit.RT8.Hook	8' Hook Round Track	599.00	658.90	658.90
Kit.RT8.HS	8' Horseshoe Round Track	615.00	676.50	676.50
Kit.RT8.Round	8' Round Stick Round Track	579.00	636.90	636.90
Kit.RT8.Spade	8' Spade Round Track Hammered	748.00	822.80	-
Kit.RT8.Square	8' Square Stick Round Track	583.00	641.30	641.30
Kit.RT8.Three	8' Three Point Round Track	631.00	694.10	694.10
Kit.RT8.TM	8' Top Mount Round Track	583.00	641.30	641.30



[Parts](#)

Item	Parts For Round Track	List Black	List ORB	List 619
RT.Strap.Spade	Hanger Ea. Spade Hammered	97.00	106.70	-
RT.Strap.Fleur	Hanger Ea. Fleur-de-Lis Hammered	101.00	111.10	-
RT.Strap.Square	Hanger Ea. Square Stick	40.00	44.00	44.00
RT.Strap.Hook	Hanger Ea. Hook	48.00	52.80	52.80
RT.Strap.HorseShoe	Hanger Ea. Horseshoe	56.00	61.60	61.60
RT.Strap.Round	Hanger Ea. Round Stick	38.00	41.80	41.80
RT.Strap.TM	Hanger Ea. Top Mount	40.00	44.00	44.00
RT.Strap.ThreePT	Hanger Ea. Three-Point	64.00	70.40	70.40
RT.Track4	4 ft Rail Only	88.00	96.80	96.80
RT.Track6	6 ft Rail Only	128.00	140.80	140.80
RT.Track8	8 ft Rail Only	294.00	323.40	323.40
RT.TAP	1/4"-20 Standard Tap	16.00	17.60	17.60
RT.TrackStop	Rail End Cap Set for Round Track	40.00	44.00	44.00
RT.Ball	Rail 1-1/2 in. Ball End Cap Kit	80.00	80.00	80.00
RT.DD402	Double Door Center Stop	11.00	12.10	12.10
RT.SPLICE	Splice Kit for Round Rail	18.00	19.80	19.80
RT.Brace	Wall Mount Rail Bracket: Doors 1-1/2 in. to 2-1/4 in.	16.00	17.60	17.60
RT.ShortBracket	Short Wall Mount Rail Bracket: Doors 3/4 in. to 1-1/2 in.	16.00	17.60	17.60
Floor.Guide.1403.622	Floor Guide for Wood Door-Black Plastic	3.00	-	-
Floor.Guide.1403.630	Floor Guide for Wood Door-Stainless Steel	-	-	12.10
RT.CenterRoll	Rolling Center Guide Black	35.00	-	-
RT.CenterSpade	Spade Center Guide	64.00	70.40	-
RT.CenterFleur	Fleur-de-Lis Center Guide	35.00	38.50	-
RT.CenterDome	Dome Guides	18.00	19.80	19.80
RT.DS.SpadeLH	Spade Left Stop	35.00	38.50	-
RT.DS.SpadeRH	Spade Right Stop	35.00	38.50	-
RT.DS.FleurLH	Fleur-de-Lis Left Stop	35.00	38.50	-
RT.DS.FleurRH	Fleur-de-Lis Right Stop	35.00	38.50	-
RT.DomeStop	Dome Stop (non-handed)	18.00	19.80	19.80



RT.CenterRoll



RT.DD402



RT.Ball



RT.SPLICE

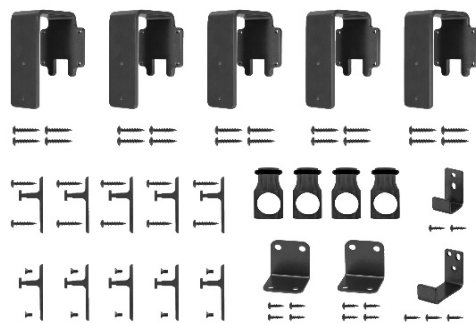

Bypass for Round Track - Call for Quote

Call for Quote

Item	Stainless Steel Barn Door Hardware Kits: 6' & 8'
FSS.6	Kit 6.6 ft. Flat Rail Stick Barn Door Hdwe Stain. Steel
FSS.8	Kit 8 ft. Flat Rail Stick Barn Door Hdwe Stain. Steel
TM100.6	Kit 6'6 Round Rail Top Mount Stick Barn Door Hdwe Stain. Steel
TM200.6	Kit 6'6 Round Rail Top Mount Dual Barn Door Hdwe Stain. Steel
TM300.6	Kit 6'6 Round Rail Top Mount Spoke Barn Door Hdwe Stain. Steel
FM100.6	Kit 6'6 Round Rail Strap Barn Door Hdwe Stain. Steel
FM200.6	Kit 6'6 Round Rail Dual Wheel Strap Barn Door Hdwe Stain. Steel
FM300.6	Kit 6'6 Round Rail Triangle Strap Barn Door Hdwe Stain. Steel
TM100.8	Kit 8' Round Rail Top Mount Barn Door Hdwe Stain. Steel
TM200.8	Kit 8' Round Rail Top Mount Dual Barn Door Hdwe Stain. Steel
TM300.8	Kit 8' Round Rail Top Mount Spoke Barn Door Hdwe Stain. Steel
FM100.8	Kit 8' Round Rail Strap Barn Door Hdwe Stain. Steel
FM200.8	Kit 8' Round Rail Dual Wheel Strap Barn Door Hdwe Stain. Steel
FM300.8	Kit 8' Round Rail Triangle Strap Barn Door Hdwe Stain. Steel

Item	Stainless Steel Components
TM-FM.RAIL.6	Stainless Steel 6.6 ft. Round Rail, 4 Mounting Brackets, 2 End Caps
TM-FM.RAIL.8	Stainless Steel 8 ft. Round Rail, 5 Mounting Brackets, 2 End Caps
TM-FM.SPLICE	Track Connector for TM and FM Series
TM.Strap.100	Hanger Ea. Only Top Mount Stick Deseign
TM.Strap.200	Hanger Ea. Only Top Mount Dual Wheel
TM.Strap.300	Hanger Ea. Only Top Mount Spoke Wheel
FM.Strap.100	Hanger Ea. Only Face Mount Stick Design
FM.Strap.200	Hanger Ea. Only Face Mount Dual Wheel
FM.Strap.300	Hanger Ea. Only Face Mount Triangle
Floor.Guide.1403.630	Stainless Steel Floor Guide for Wood Door
FSS.Strap.Stick	Hanger only Ea. For FSS Design
FSS.RailStop.LH	Rail End Stop Left for FSS Design
FSS.RailStop.RH	Rail End Stop Right for FSS Design
FSS.TRACK.6	Track for FSS 6.6 ft. with 5 Mounting Brackets and Spacers
FSS.SPLICE	Connector for FSS Stainless Steel Flat Track



TM100



TM200



TM300



FSS



FM100



FM200



FM300

[Wall Mount: Housed Track](#)

300 lbs: Min. Door Thick 1-1/8"		List
200WM72	One 3'0" Door	294.00
200WM96	One 4'0" Door	342.00
Fascia 8' Bronze	8' Bronze for 2610FB	188.00
Fascia 16' Bronze	16' Bronze for 2610FB	359.00
125 lb Zinc Track; Door Thick 1" to 1-3/4"		List
2610F72	One 3'0" Door	115.00
2610F96	One 4'0" Door	145.00
Upgrade 200 lb	see 1125 in Pocket Hardware	-
200 lb Bronze Track; Door Thick 1" to 1-3/4"		List
2610FB72	One 3'0" Door	183.00
2610FB96	One 4'0" Door	236.00
Parts		List
12 Guide	Wall Mount Door Guide 1-1/8" to 1-3/4"	2.00



200W pictured



2610FB pictured



12



Fascia

[Decorative Handles](#)

Item	Specify Black, Satin Nickel, Oil Rub Bronze	List
HF901	OAH 9" OAW 1-3/4" Projection 1-5/8"	55.00
HF902	OAH: 6-3/4"; OAW 1-3/4"; Projection 1-5/8"	92.00
HF903	OAH 8-5/8" OAW 1-3/4" Projection 1-5/8"	90.00
HF904	OAH 8-5/8" OAW 12-1/2" Projection 2-1/4"	168.00
HF905	OAH: 10" OAW: 1-7/8" Proj.: 1-1/2"	59.00
HF906	OAH: 11" OAW: 2-3/4" Proj.: 1-1/2"	42.00
HF907	OAH: 8-3/4" OAW: 1-5/8" Proj.: 1-1/4"	39.00
HF908	OAH: 8-1/2" OAW: 1-7/8" Proj.: 1-1/2"	59.00
HF909	OAH: 8-7/8" OAW: 1-7/8" Proj.: 1-1/2"	38.00
HF910	OAH: 8-5/8" OAW: 1-13/16" Proj.: 1-1/2"	35.00
P399	Length: 13" Width: 3-1/2" Projection: 3"	60.00



HF901



HF902



HF903



HF904



HF905



HF906



HF907



HF908



HF909



HF910



P399

[e of Contents](#)

Exterior Shutter Hardware

Item	Package	Description	List
AK1	set of 2 pr	Shutter Hinge 1-1/4" offset	81.00
AK2	set of 2 pr	Shutter Hinge 2-1/4" offset	89.00
AK3	set of 2 pr	Connecticut Hinge 4" Flat	45.00
AK4	pair	Shutter Dogs - Aluminum	48.00
AKA	set of 2 pr	Connecticut Hinge 5-1/8" w/2-3/16" offset	107.00
AKB	set of 2 pr	Connecticut Hinge 6-7/8" flat	107.00
AKE	each	Adjustable Pintel	35.00
AKF	each	Strap Hinge & Pintel Flush 13-3/8"	86.00
AKG	each	Strap Hinge & Pintel 1 1/4" offset, 13"	86.00
AKH	each	Strap Hinge & Pintel 2 1/4" offset, 12 1/4"	86.00
AKM	set	Connecticut Hinge 5-1/8" w/1-1/4" offset	107.00
AKZ	each	Acorn Bullet Catch	26.00
RK1	pair	Butt Hinge 3x4 Maximum Throw 1-1/2"	66.00
RK2	pair	Butt Hinge 3x5 Maximum Throw 2-1/2"	68.00
RK3	pair	Butt Hinge 3x6 Maximum Throw 3-1/2"	72.00
RL9	each	Shutter Bolt Length: 6-5/8"	67.00
RLA	each	Shutter Bolt Length: 6"	67.00

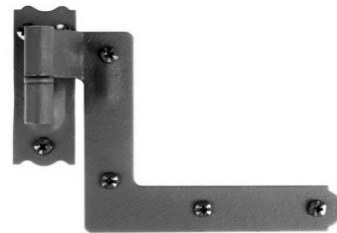

AK1 & AK2



AK4



AKF: Flush, 13-3/8" strap length
 AKG: 1 1/4" offset, 13" Strap length
 AKH: 2 1/4" offset, 12 1/4" Strap length

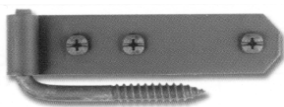

AK3: 4" flat
 AKA: 5-1/8" w/2-3/16"
 AKM: 5-1/8" w/1-1/4"
 AKB: 6-7/8" flat



RK1: 3x4 Maximum Throw 1-1/2"
 RK2: 3x5 Maximum Throw 2-1/2"
 RK3: 3x6 Maximum Throw 3-1/2"



RL9BP: Back Plate: 6-7/8" x 1-11/16"



AKE: Backplate 1 1/2" x 4 1/2"
 Pintel 4-7/8" x 3/8"



RLABP: Bolt 6"; Back Plate: 2-1/4" x 1-1/4"



AKZ 9/16" x 1-1/4"

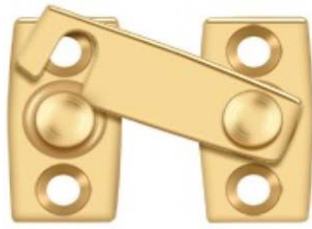

SB30 Shutter Bar: 1-1/8"

	Finish	List SB30
605	Bright Brass	13.50
609	Antique Brass	15.10
613	Oil Rub Brz	15.10
619	Satin Nickel	15.10
620	Pewter	15.10
625	Bright Chrome	15.10
626	Sat Chrome	15.10
PVD	Brass Lifetime	17.70

SB31 Shutter Bar: 1-3/8"

	Finish	List SB31
605	Bright Brass	18.50
609	Antique Brass	20.20
613	Oil Rub Brz	20.20
619	Satin Nickel	20.20
620	Pewter	20.20
625	Bright Chrome	20.20
626	Sat Chrome	20.20
PVD	Brass Lifetime	23.50

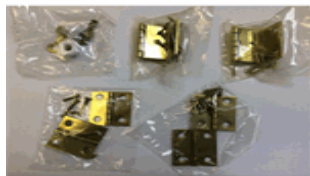

H298 Shutter Hardware

	Finish	List
605	Bright Brass	12.00

Bifold Shutter Hardware

Item	Description	List
174PIV	Pivot Set	12.00
1742	Hanger	9.00
170a-24	shutter track	6.10
170a-30	shutter track	7.50
170a-32	shutter track	7.90
170a-36	shutter track	9.00
170a-48	shutter track	12.00
170a-60	shutter track	14.00
170a-72	shutter track	16.40
170a-96	shutter track	21.90

Interior Shutter Hardware Parts		
Item	Description	List
H16.605	pr Hinge Bright Brass	5.00
H16.609	pr Hinge Antique Brass	8.00
H16.625	pr Hinge Bright Chrome	10.00
H1256.605	pr Hinge Bright Brass	15.00
H5.605	pr Hinge Bright Brass	4.00
H6144.605	pr Hinge Bright Brass	2.00
H6148.605	pr Hinge Bright Brass	3.00
H6155.605	pr Hinge Bright Brass	3.00
H7.605	pr Hinge Bright Brass	3.00
K218.605	Brass Knob 1-3/4"D	4.80
K218.609	Antique Brass Knob	2.40
K218.626	Satin Chrome Knob	2.40
K626	Sat Chrome Knob 7/8"D	4.40
MC5100	Magnetic Catch	1.00
D326	Double Magnetic Catch	1.00
BBS	Shutter Bead Board	6.00
TL5300	Touch Latch	1.00

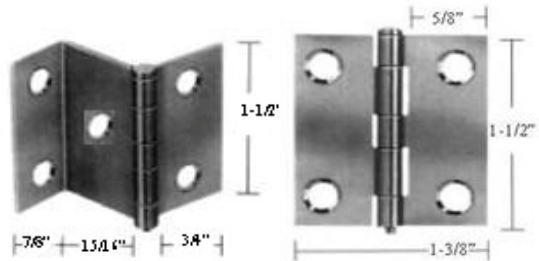

H6155

H6148

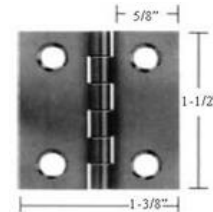

H6144

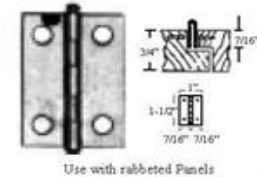

H7



H5



H16



H1256



K218