

B&B Wood Products inc.

Barn, Sliding and Folding Hardware

Table of Contents	Page
Wall Mount Slide	2
Stainless Steel Barn	3
Designer Barn Hardware	4
USA Barn Hardware	5
Round Rail Barn Hdwe	6
Barn Handles	7
Sliding Door Hardware	8
Pocket Hardware	9
Soft Close & parts	10
Barn Door Exterior	11
Sliding Door Accessories	12
Pocket Door Locks	13
Bifold Hardware	14
Multi-Fold Hardware	15



Wall Mount Sliding Door Hardware

Wall Mounted Sliding Door Hardware is ideally suited for applications where it is cost prohibitive or structurally impossible to install a pocket door. Installation is relatively straight forward and can be performed with minimal expertise. The track system can be covered and trimmed out by the installer to match other doors or millwork in the project. Note: See www.bbwood.com for installation instructions.



Single Wall Mount Sliding Door



Converging Wall Mount Sliding Doors

200WM SERIES: Minimum Door Thickness: 1-1/8" Maximum Door Weight: 300 lbs. per door.



The 200WM is a commercial grade wall mounted sliding door hardware system designed to carry heavy doors. The 200WM Hardware Set features heavy-duty extruded aluminum I-beam track, heavy-duty track mounting brackets and strong four wheel adjustable hangers with machine turned ball bearing wheels. 11-13 gauge zinc dichromate plated steel parts. Brackets (2006) should align with wall studs. End brackets within 8" of end of track. Fascia is an option in Bronze or Satin.

Kits Include: Track, hangers, guides, brackets and end stops

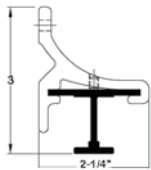

200 Track



2055 Stop



12 Wall Guide



2006



2020 Hanger



2030 Floor Guides

Option: Fascia



Bronze



Satin

Stocked in two sizes. Track can be cut on the job for smaller openings. Call for quote on track up to 16'. Hangers are available separately when two doors are used in one opening.

Item	Door Size
200WM72	One 3'0" Door
200WM96	One 4'0" Door
Extra pr 2020	Add for 1 pair
Option: Fascia 8'	Bronze w/Caps
Option: Fascia 8'	Satin No Caps

2610 SERIES:

Door Thickness: 1" to 1-3/4" Max Weight per Door: Zinc 125 lb; Bronze 200 lbs.



The 2610 is a commercial grade wall mounted sliding door hardware set designed for fast installation. Precision extruded aluminum box track features a built in fascia that hides the sliding hardware from view. Strong 3-wheel hangers are completely adjustable. Bronze series has ball bearing wheels for doors up to 200 lbs. Zinc series for doors up to 125 lbs. Bronze features an extruded architectural grade dark bronze anodized track.

Kits Include: Track, hangers, guides, end caps & end stops

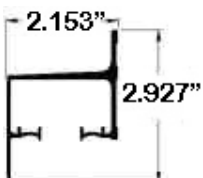

2610



Zinc: 1120 Hangers
BRZ: 1125 Hangers



2682 End Caps



1155 End Stops



12 Wall Guide



2030 Floor Guides

Stocked in two sizes. Track can be cut on the job for smaller openings. Call for quote on track up to 16'. Hangers are available separately when two doors are used in one opening.

Zinc - 125 lb	Door Size
2610F72	One 3'0" Door
2610F96	One 4'0" Door
Bronze -200 lb	Door Size
2610FB72	One 3'0" Door
2610FB96	One 4'0" Door
Extra pr 1125	Add for 1 pair
Extra #12	Add for 1 each
Extra #2030	Add for 1 each

Soft-Close see pg. 10

Stainless Steel Wall Mount Hardware - For 6' & 8' Openings



FSS: Flat Rail for 1-5/16" to 1-3/8" Doors

Max. loading weight: 220 lbs

Kit Includes:

- 2 - Stick Strap in 304 Stainless Steel Rail, Mounting Brackets and Screws
- 1 - Left & Right Rail Stop
- 2 - Anti-jump Block
- 1 - Floor Center Guide for Wood Door

Options: FSS-Splice Kit, FSS.Track with brackets.

TM/FM: Round Rail for 1-1/4" to 2-5/8" Doors

Kit Includes:

- 2 - Top Mount or strap in 304 Stainless Steel Rail & Mounting Brackets;
- 2 - End Stops
- Floor Center Guide & Spanner Tool Set

Options: TM-FM-Splice Kit, TM-FM.Rail kit with brackets.



TM100



TM200



TM300



FM100



FM200



FM300

Designer Flat Track Barn Door Hardware: 6'6"

For interior use with wood doors ranging from 1-3/8" to 1-3/4" thick.

MFS5-6 Kit: Max loading weight 110 lbs.

2 - Hook Sliding Door 5" Roller, Steel Black

1 - Flat Rail (78-3/4" with 5 mounting brackets)

2 - Rail Stop

2 - Anti-Jump Block

1 - Plastic Floor Center Guide (for wooden doors)

- Max. loading weight: 110 lbs.

- Fits 32" and 36" openings.

- For bypassing doors, purchase two (2) of this MFS5-6 kit, along with five (5) MFS23



MFS3-6 Kit: Max. loading weight: 220 lbs

2 - Hook Carrier 2-3/4" Wheel

1 - Rail 78-3/4" Long with 5 Mounting Brackets

2 - Rail Stops

2 - Anti-jump Blocks

1 Plastic Floor Center Guide for Wood Door



See store.bbwood.com for more colors including White, Oil Rubbed Bronze, Satin Nickel & more

Designer Flat Track: Accessories



MFS23 Steel Bypass Door Bracket, Black

For a complete bypass set for a 6' kit you must purchase 5 bypass brackets and two sets of MFS3-6 or MFS5-6.

Includes:

2 - Hex Screws w/ Washers

1 - Hex Bolt w/ Washers & Nut



MFS24 Soft-Close Mechanism, Black

1 MFS24 will do a soft open and close on 1 track.

Includes:

2 - Soft Close Mechanism (L & R)

2 - Actuator

For soft open and soft close purchase 2-kits.



MFS19 Steel Rail Connector, Black

Includes:

1 - Connector

4 - Flat Head Screws 1/4-20 Thread

Flat Track USA Barn Door Hardware - 4', 6' & 8'

For interior use with wood doors ranging from 1-3/8" to 1-3/4" thick.

The wheels are made up of high density PVC for a quieter and smoother rolling door. The rails and brackets are made out of sturdy extruded aluminum, making them light weight but strong. The aluminum has a powder-coated black finish, Rated for 250 lbs.

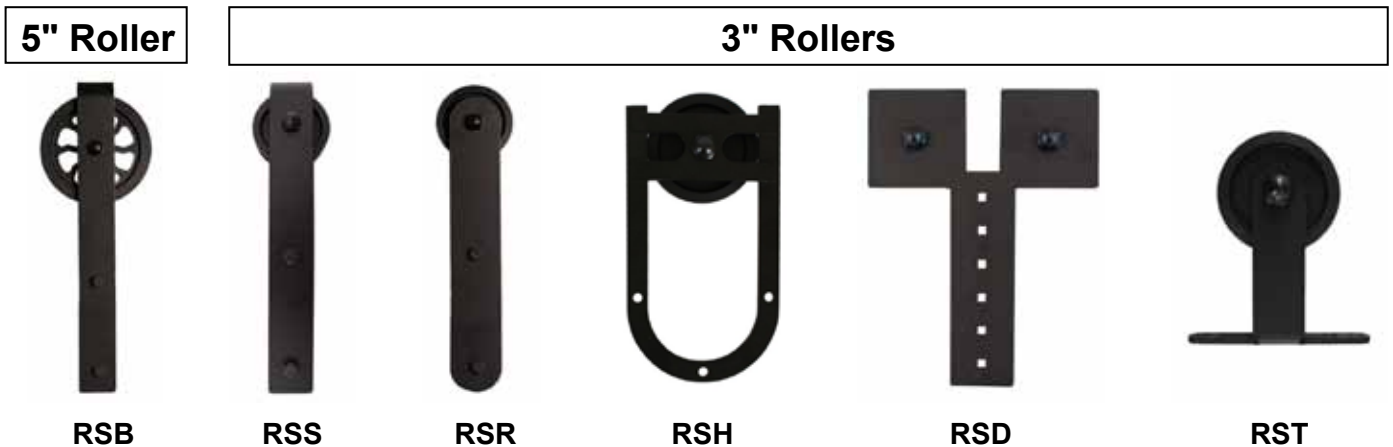

- Made in the USA
- Powder coated Black components
- 3" & 5" diameter PVC wheel
- Kits include Aluminum rails, hangers, stops, guide, and all fasteners
- Interior Use Only



RSB-6 package of hardware



Kits sold for 4', 6', and 8' openings.
Rail Connector is available to double your opening size.

Sold in kits or as components - see store.bbwood.com

Gap between the wall and the door: 1-15/16" minus door thickness.

Round Rail Barn Hardware - for up to 250 lb. Doors

Black, Oil Rubbed Bronze and Satin Nickel

Includes: 2 Roller Straps; 1 Center Guide; 1 Left & 1 Right Stop; Wall Brackets (every 16"); 2 Track Button End Stops; 1 Tap

Stock	Stock - Hand Forged
-------	---------------------

						<p>Note: Spade & Fleur-de-Lis have a hammered finish. Sold in Black and ORB.</p>
Round Stick 2.75"W x 6.67"H	Square Stick 2.9"W x 6.8"H	Horse Shoe 4.12"W x 6.17"H	Hook 2.5"W x 7.75"H	Spade 3" W x 10.5"H	Fleur-de-Lis 3.25"W x 11.75"H	

See store.bbwood.com for all designs

						
Deco 3"W x 6"H	Diamond 2.625"W x 8.625"H	Geo 3"W x 6.5"H	Pulley 2"W x 4.86"	Stick 2.5"W x 6.67"H	Three Point 4.5"W x 5.5"H	V8 5.38"W x 7.25"H

Kits sold for 4', 6', and 8' openings. Rail Connector is available to double your opening size.



Gap between the wall and the door:
2-1/2" minus door thickness.

Options

	<p>Roller Center Guide:</p> <p>For doors with rough surfaces, Constructed of heavy duty black polymer</p> <p style="text-align: right;">RT.1000</p>
	<p>Ball Track End Stop: 1-1/2"</p> <p>Priced per pair. RT.BALL</p>
	<p>Splice Kit</p> <p style="text-align: right;">RT.SPLICE</p>
	<p>Bi-Parting Center Door Stop:</p> <p style="text-align: right;">RT.DD402</p>

Wall Mount Handles

HF series is hand forged. Available in Black, Satin Nickel, Oil Rubbed Bronze and Rust.



P399 Pictured



HF901
OAH 8-7/8"
OAW 1-7/8"
Proj 1-5/8"



HF902
OAH 6-3/4"
OAW 1-7/8"
Proj 2"



HF903
OAH 8-5/8"
OAW 1-3/4"
Proj 1-5/8"



HF904
OAH 8-5/8"
OAW 12-1/2"
Proj 2-1/4"



HF905
OAH: 10"
OAW: 1-7/8"
Proj.: 1-1/2"



HF906
OAH: 11"
OAW: 2-3/4"
Proj.: 1-1/2"



HF907
OAH: 8-3/4"
OAW: 1-5/8"
Proj.: 1-1/4"



HF908
OAH: 8-1/2"
OAW: 1-7/8"
Proj.: 1-1/2"



HF909
OAH: 8-7/8"
OAW: 1-7/8"
Proj.: 1-1/2"



HF910
OAH: 8-5/8"
OAW: 1-13/16"
Proj.: 1-1/2"



P399
OAH: 13"
OAW: 3-1/2"
Proj: 3"

Round Rail Bypass Kit

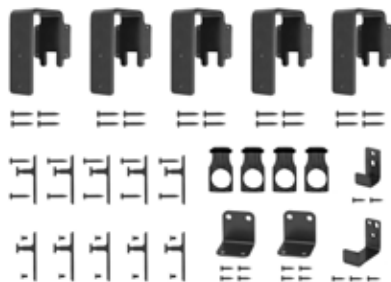

To be used with Round Rail Rolling Door Hardware
Black, Satin Nickel or ORB Finish

Includes:

- 5 Rail Brackets w/long screws
- 5 Rail Brackets w/short screws
- 4 Steel Door Stoppers
- 1 Wall Mounted Guide
- 1 Floor Mounted Guide
- 2 Stop Slots

Model:
RT.Bypass

For bypass application, 1 kit and 2 rolling door kits are required

Sliding Door Hardware (parts see page 10)

Bypass Door Hardware - No Fascia

For doors to 50 lbs each. 3/4" or 1-3/8" thick doors.

Finished Opg. Height = Door + 1-3/4"

Description	Steel Track (Gold)	Alum Track
For Two 2'0" Doors	1166-48	2200-48
For Two 2'6" Doors	1166-60	2200-60
For Two 3'0" Doors	1166-72	2200-72
For Four 2'0" Doors	1166-96-4	2200-96-4



50 lbs
3/4" to 1-3/8"

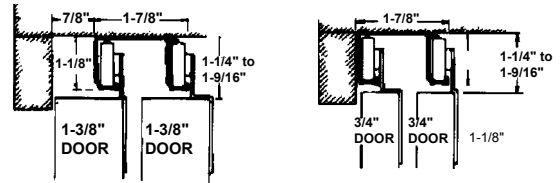

Bypass Door Hardware - Aluminum Track with Fascia

2200F For doors to 75 lbs each, 1-3/8" thick

Includes 2228 hangers & Brass 3/4" pulls.

Finished Opg. Height = Door + 1-3/4"

Description	Item
For Two 2'0" Doors	2200F-48
For Two 2'6" Doors	2200F-60
For Two 3'0" Doors	2200F-72
For Four 2'0" Doors	2200F-96-4



75 lbs
1-3/8"

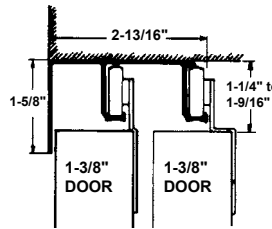

134F For doors to 125 lbs each, 1-3/4" thick

Includes 1120 hangers & Brass 2-1/8" pulls

Finished Opg. Height = Door + 2-3/8"

Description	Item
For Two 2'0" Doors	134F-48
For Two 2'6" Doors	134F-60
For Two 3'0" Doors	134F-72
For Four 2'0" Doors	134F-96-4



125 lbs
1-3/4"

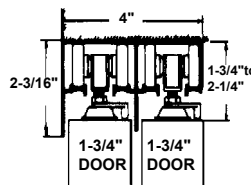

**Upgrade to 200 lbs order
1125 hangers (pg 10)**

**Upgrade to Soft-Close
order 4 - 1060 (pg 10)**

Bypass Door Hardware Sets - Alum Track No Fascia

Sets include 2 pc track, 2 pr. hangers, Dr. Guide, wrench and screws.

BP150 Set: Doors to 150 lbs each. 13/8" to 1-3/4" thick.

BP250 Set: Doors to 250 lbs each. 13/8" to 1-3/4" thick.

Finished Opg. Height = Door + 2-5/8"

For additional sizes see page 10 for parts

Description	150 Lbs.	250 Lbs.
For Two 2'0" Doors	BP150-4	BP250-4
For Two 2'6" Doors	BP150-5	BP250-5
For Two 3'0" Doors	BP150-6	BP250-6
For Two 4'0" Doors	BP150-8	BP250-8

Flush pulls not included. Meets ANSI A156.14 type D8731

150 or 250 lbs
1-3/8" to 1-3/4"

**Upgrade to Soft-Close
order 4 - 6320 (pg 10)**

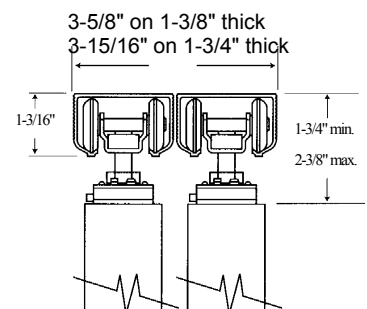

Pocket Door Hardware (parts see page 10)

Sets include 1 peice of track, 1 pr. plates and hangers, 1- PD250-74 pocket dr. Guide, wrench and screws.

PD150 Set: Doors to 150 lbs each. 13/8" to 1-3/4" thick.

PD250 Set: Doors to 250 lbs each. 13/8" to 1-3/4" thick.

R.O. height add 4-1/2" to door height

For additional sizes see page 10 for parts

Description	150 Lbs.	250 Lbs.
For 2'0" Door	PD150-4	PD250-4
For 2'6" Door	PD150-5	PD250-5
For 3'0" Door	PD150-6	PD250-6
For 4'0" Door	PD150-8	PD250-8

Meets ANSI A156.14 type D8681

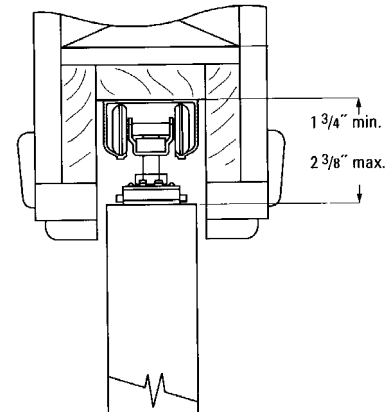

Upgrade to Soft-Close 6320 - page 10

Pocket Door Frame Kits: 1530 & 1560

Packaged for 3/0 door width and marked for cutting to smaller widths

2x4 units for 1" to 1-3/8" doors to 125 lbs. Rough Opg. = Door Ht+4-1/2"

2x6 units for 1" to 3" thick doors to 200 lbs. Rough Opg. = Door Ht. +5"



Height	2x4 Stud	2x6 Stud
6'8"	153068	15603068
7'0"	153070	15603070
8'0"	153080	15603080
9'0"	153090	15603090

1555 Converging Door Kit (Dbl Door Units)
1575 Adaptor for 1-3/4" Doors for 2x4 units pr 1125 to upgrade 2x4 units to 200 lbs.
Pair 1550 Pocket Door Guide

Upgrade 1530 to 200 lbs order pr. 1125 (page 10).

Soft-Close order 1060 (page 10)

Bypass Frame Kit 1562: see store.bbwood.com

Designed to carry 2 solid bypassing doors in a standard 2 x 6 wall or steel framed stud wall. The 1562 allows architects and designers to specify large room dividing openings with minimum wall obstruction for "clean and open" living spaces.

MAX DOOR WEIGHT: 200lbs.

DOOR WIDTHS: 18", 24", 30", 36"

MAX DOOR HEIGHT: 108"

DOOR THICKNESS: 1-3/8"

MIN WALL STRUCTURE THICKNESS: 5-1/2"

Assembled Frames Wood
Frames - store.bbwood.com

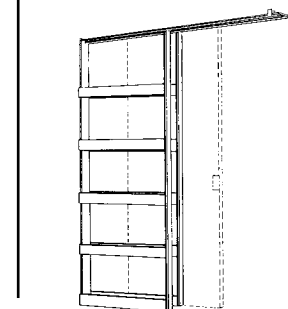

PVC SLIDING DOOR TRACK - Sold as pair of top and bottom track-Tan Color

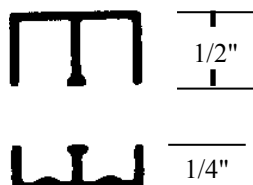

Lengths: 48", 72", 96"

M14: for 1/4" panels

M12: for 1/2" panels

M34: for 3/4" panels

Soft Close Mechanisms



The 6320 Kit contains a single soft-close actuator. Purchase with our Assembled Wood Pocket Door frame, our BP150 or PD150 hardware kits. Order two kits for each track if you want soft open and soft close. Includes PD250-HDW hangers (not pictured above).

The 1060 Kit contains a single soft-close actuator for use on 100 Johnson track. For single direction soft door operation, the 1060 must be used in combination with a 1125 Door Hanger. For bi-directional soft door operation two (2) 1060's are required.

The 1062 Soft-Close Kit contains the hardware necessary to make 1-door panel soft-close and soft-open when installed in a Johnson 100 series track profile.

The 1060SOFT Soft-Close Retrofit Kit is designed to quickly convert existing 1500 Series Pocket Door Frames to single direction soft-close door operation.

















Item	Max Dr Wt	Application	Use With
1060	200	1 Direction	Johnson 1560, 1562. For 1500, 2610, 134F order one additional 1125 hanger per door.
1060SOFT	200	1 Direction	Johnson 1500, 1560, 1562, 2610, 134F.
6320-88	88	1 Direction	Pocket BP150, BP250, Track only BP250N-01
6320-132	132	1 Direction	Pocket BP150, BP250, Track only BP250N-01

Sliding Track and Parts

PARTS	
PD150N-HDW	Pocket 125 lb w/2- hangers, guide, wrench
PD250N-HDW	Pocket 250 lb w/2- hangers, guide, wrench
BP250N-01	Aluminum Track (4' to 16')
BP150N-HDW	Bypass 125 lb w/2- hangers, guide, wrench
BP250N-HDW	Bypass 250 lb w/2- hangers, guide, wrench
BP150-41	Hanger Sold per pair
BP150-71	Floor Guide - adjustable for 3/4" to 1-3/8" doors. Size 4-5/8" x 1-1/2" x 3/4" high.
BP150-73	Nylon Floor Guide - Sold in pairs.
BP250-71	Floor Guide - adjustable for 1-3/8" to 1-3/4"
BP250-77	Center Stop - for BP250 track.
BP75-76	Double pocket door center stop
PD250-71	Bottom Guide adjustable for pocket door frame
PD250-72	Pocket Guide for 1-3/4" door
PD250-74	Pocket Guide - Provides 3/4" vertical adjustment for 1-3/8" door. Size 3/4" x 7/16" x 1/4" High.
PD250-77	Bumper Stop
TR250	Track Spacer for BP250 track
1120 - Hangers (for 134F & 1560 series)	Sold per pair
1125 - Hangers 200 lb (for 134F & 1560 series)	Sold per pair
2054	Pull for Multi-Pass applications Sold per Set
2136	Carpet Riser .62" High
2216 or 2238 - Hangers (for 1166 - 2200 series)	List each
2228 - Hangers (for 2200F series)	Sold per pair
2312 (PD75)	Universal hanger for "V" track 7/8" diam. Wheel
2802 - Hangers (for 2850 pocket series)	Sold per pair

Bypass and Pocket Parts

More parts shown on store.bbwood.com

	BP150-41		BP2054
	BP150-71		2136
	BP150-73		2216
sold each			1/16" Offset
	BP250-71		2238
			3/8" Offset
	BP250-77		2228
			3/8" Offset
	BP75-76		2228
	PD250-72		2802
	PD250-74		2312
	PD250-76		
	Stop		
	1120		
	1125		

B&B Wood Products inc.

Exterior Barn Door Hardware - for doors up to 400 lbs.

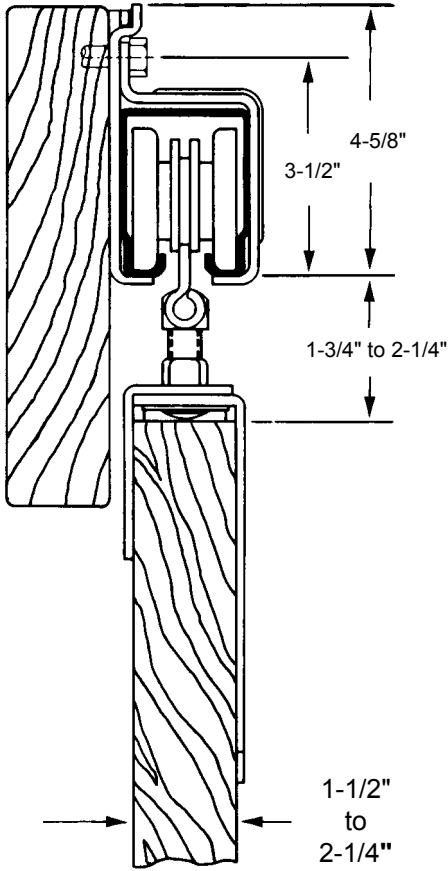

Bolts furnished for doors up to 1-3/4" thick



Track: 8' to 12'
BD301



Hangers (pair)
BD32LB



Side Bracket
BD1-301



End Cap
BD301EC
Use with bracket



Splice Bracket
BD1L-301



Ceiling Bracket
BD3L-301



Double Side Bracket
BD5-301



Door Holder/Stop
BD65
Max Dr Width 2-1/4"



Stake Holder
BD67
7-3/4" w x 2-1/2" h



Center Stop
BD78*
*Close-Out



Guide - up to 1-3/4"
BD79

Recommended spacing for brackets is 24"

Brackets for metal buildings see store.bbwood.com



Stay Roll
BD92
For 1-1/2" to 2-1/2" drs



Stay Roll
BD95
For 1-1/4" to 2-5/8" drs



Stay Roll
BD96
For 1" to 3-3/4" drs



Stay Roll- 6" lag
BD98*
*Close-Out



Jamb Latch 7". Doors 1-1/2" and greater
BD120



Sliding Latch Zinc. Accepts a padlock.
BD124



Sliding Bolt Latch, doubles as pull. Reversible.
BD125



Door Pull - 7-7/8" Zinc
BD208

SLIDING & POCKET DOOR ACCESSORIES

FLUSH PULLS



P218
1" Diam.
Fits 3/4" hole



P221:
2-7/16" Diam
Fits 2-1/8" hole



P223:
1-5/16" x 3-9/16"



P222:
1-5/16" x 3-1/8"



P227:
1-3/4" x 3-5/8"

Fits std
2-1/8"
diam. hole



P221SQ
2-1/2" x 2-1/2"



P2276
1-3/4" x 6"



P2277
2" x 7"



P22710
2" x 10"



P22157
2-7/8" x 7-1/4"



P22167
2-1/2" x 7-1/2"

EDGE PULL - P230



3/4" x 3-7/8"

P230

	FINISH
605	Bright Brass
609	Antique Brass
612	Satin Bronze
613	Oil Rub Bronze
619	Satin Nickel
620	Pewter
622	Black
625	Bright Chrome
626	Satin Chrome

Solid Brass

12

info@bbwood.com

POCKET DOOR BOLT - P42



P42

OA 3-1/16" x 1-5/32"
Strike: 1" x 3/4"
Depth of Mortise: 5/8"

- Ideal for single or pairs of doors to provide privacy function.
- Emergency release of bolt is accomplished by drilling a small hole in the door (grommet provided). A thin object inserted into the hole will push the rocker back to the unlocked position. Mounted on the jamb side of a pocket door. It works like a rocker switch. When pushed in, the other half pops out, physically preventing the door from returning into its pocket. A strike is provided to protect the jamb.

	FINISH
605	Bright Brass
609	Antique Brass
613	Oil Rub Bronze
619	Satin Nickel
620	Pewter
622	Black
625	Bright Chrome
626	Satin Chrome

Door
Edge Jamb

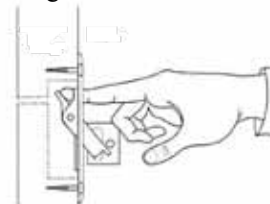

Store.bbwood.com

SLIDING & POCKET DOOR LOCKS

POCKET DOOR LOCKS



PDL100
Passage



PDL101*
Privacy

Door cut out 1-3/4" deep x 2-1/4" high
*Fits doors 1-1/8" to 1-1/2"

	FINISH
605	Bright Brass
609	Antique Brass
613	Oil Rub Brz
716	Aged Bronze
619	Satin Nickel
620	Pewter
622	Black
625	Bright Chrome
626	Satin Chrome

*For 1-3/4" specify PDL101-134



PDL2101
Passage



PDL2102
Privacy

Door cut out 1-3/4" deep x 3-1/8" high
Fits doors 1-3/8" to 1-3/4".

Available in finishes:
Polished Brass (605), Antique Brass (US7), Oil-Rub-Brz (613), Satin Nickel (619), Pewter (620), Flat Black (622), Polished Chrome (625) & Satin Steel

MORTISE POCKET DOOR LOCKS



PDL210 Classic



PDL211 Modern

Polished Brass; Oil Rub Bronze;
Satin Nickel; Pewter; Polished
Chrome, Medium Bronze,
Tumbled White Bronze

Polished Brass; Satin Brass;
French Antique; Oil Rubbed
Bronze; Polished Nickel (618);
Satin Nickel; Pewter; Flat Black;
Polished Chrome

PDL2103	PDL2113	Keyed	store.bbwood.com
PDL2104	PDL2114	Passage	
PDL2105	PDL2115	Privacy	
PDL2106	PDL2116	Dummy	

Specify thickness of door on Keyed and Privacy. Plate thickness 1/16". Dummy set will accept latch from keyed and privacy. Requires 3-7/8" deep mortise pocket in stile. Keylocks cannot be keyed to other Emtek keyways.

POCKET DOOR LOCK



P1521 Privacy/Passage: 1-3/8" thick doors

- Uses 2-1/8" Bore & 2-3/8" backset like swinging doors
- Automatic latching when shut
- All units fully reversible
- Ideal for double door pockets. A "P1521" is used in one door, matching "P21" dummy pulls in the other. Edge pulls are recommended.

	FINISH
605	Bright Brass
609	*Antique Brass
619	Satin Nickel
622	Black

*Antique Brass is a close-out

BIFOLD HARDWARE

1825 SERIES: 1-1/8" to 1-3/4" doors to 35 lbs. each (7/16" pivot hole). Finish Height = Door Ht+1-3/4"

2-Door Sets Finish opg size 2xDr width + 9/16"

4-Door Sets Finish opg size 4xDr width + 11/16"

Item #	
1825-24	For openings to 24"
1825-30	For openings to 30"
1825-32	For openings to 32"
1825-36	For openings to 36"

Item #	
1825-48	For openings to 48"
1825-60	For openings to 60"
1825-72	For openings to 72"
1825-96	For openings to 96"

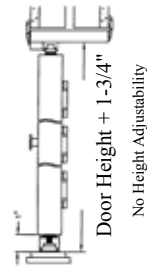

BF-50 SERIES - 1" to 1-3/4"

Item	
BF5024	For openings to 24"
BF5030	For openings to 30"
BF5036	For openings to 36"
BF5048	For openings to 48" - 4-DR
BF5060	For openings to 60" - 4-DR
BF5072	For openings to 72" - 4-DR

BF-125 SERIES-1" to 1-3/4"

Item	
BF12524	For openings to 24"
BF12530	For openings to 30"
BF12536	For openings to 36"
BF12548	For openings to 48" - 4-DR
BF12560	For openings to 60" - 4-DR
BF12572	For openings to 72" - 4-DR

Heavy Duty Hardware

Series BF-50

Up to 50 lbs. each door max. 2-doors to a jamb .
Up to 30 lbs. each door for 2+ drs to a jamb.
Door height 2-3/8" less than finished opg. height

Series BF-125

Up to 125 lbs. each door max. 2-doors to a jamb .
Up to 75 lbs. each door for 2+ drs to a jamb.
Door height min. 2-7/8" less than finished opg. height

Meets ANSI A156.14 type D8621, D8642, D8652, D8661

Meets ANSI A156.14 type D8621, D8641, D8651, D8661

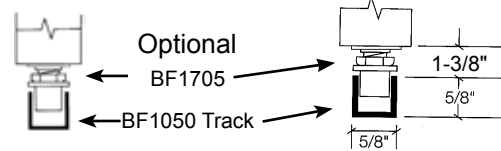
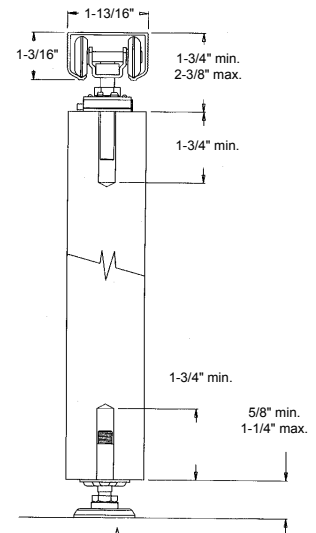
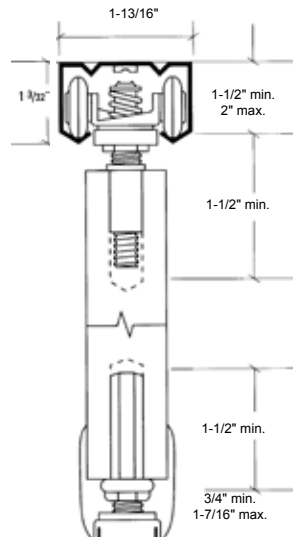

BF-50 & BF-125 Series Parts	
	BF50-41 Three Wheel Hanger
	BF50-HDW Pivot Set
	BF50-01 Aluminum Track (4' to 16')
	BF50-11 Top Pivot Bracket
	BF50-22 2-Door Snugger
	BF50-24 4-Door Snugger
	BF50-36 Birch Knob 1-3/4" diam.
	BF50-60 Plastic Knob 1-3/4" diam.
	BF50-81 Jamb Bracket
	BF125N-41 Ball Bearing Hanger
	BF125N-31 Pivot Set
	BF250N-01 Aluminum Track (4' to 16')
	BF1705 Guide Roller
	BF1050 Bottom Guide Channel-8'
1825 Series Parts	
	1801 Top Pivot Guide
	1805 pr Hinges (price per pair)
	1807 Bottom Pivot
	1808 pr 4-Dr Aligner aka BF50-72
	1836 Carpet Riser
	1861 Jamb Bracket

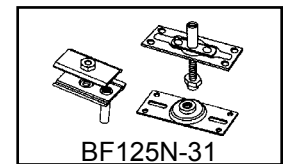
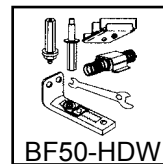

More parts shown on store.bbwood.com

B&B Wood Products inc.

Multi-Fold Hardware

Designed to work with even number of door panels only (2, 4 or 6) from each direction or converging (4, 8 or 12) panels configurations from two directions. Multi-folding door hardware can be mounted to the top of door panels in the following ways.

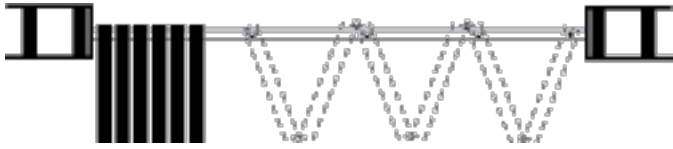

Doors hung from top edge of each panel

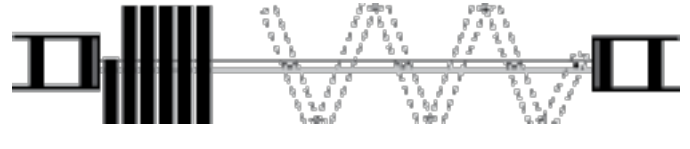

Doors hung from top center of each panel

200RD Series

Door Thickness: 1-1/8" to 1-3/4". Max Door Weight: 75 lbs. ea. Max Dr Size: 36" x 108"



The 200RD is a multi-folding door hardware set designed to carry large heavy panels. Precision extruded aluminum 'I' beam track is available in lengths up to 192". Heavy duty pivots and guides effectively control heavy panel movement and facilitate smooth operation. 11-13 gauge zinc dichromate plated steel components for a quality appearance and corrosion resistance. 6 panels max. each direction. Minimum door width 12"
 Order: 1) Track 2) 2015BS-A" for first set of panels from jamb. 3) "2002PLBG" for every pair of panels after 1st pair. Hinges sold separately - Order Ball Bearing Mortise.

Track sold in 36", 48", 60", 72", 96", 106", 120", 144", 192" lengths

$$\text{Finish Width} = \# \text{ of Doors} \times (\text{Dr Width} + 1/16") + 9/16"$$

$$\text{Finish Height} = \text{Door height} + 4-1/4"$$

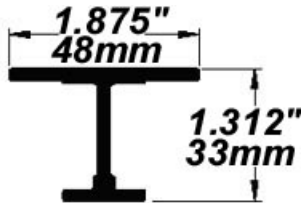

200 Track



2015BS-A



2002PLBG

2015BS-A	Basic Set
2002PLBG	Hanger
209PIV-S	Pivot set
200 Track	per lineal ft

100RD Series

Door Thickness: 1" to 1-3/4". Max Door Weight: 50 lbs. ea. Max Dr Size: 24" x 108"



100RD is a multi-folding hardware set for panels up to 24" wide & 108" tall. Track lengths to 192", available with optional bottom track for extra rigidity. Convex aluminum track, 14-16 gauge plated steel components. Includes positive pivot lock, top hung three-wheel 1" dia. ball-bearing hangers, non-mortise lift off hinges and adjustable floor mount bottom pivot bracket. 6 panels max. each direction. Minimum door width 12".
 Order: 1) Track 2) "1015BS-A" for first set of panels from jamb. 3) "1030AOSB" for every pair of panels after 1st pair. Surface hinges included.

Track sold in 36", 48", 60", 72", 96", 106", 120", 144", 192" lengths

$$\text{Finish Height} = \text{Door height} + 2-7/8"$$

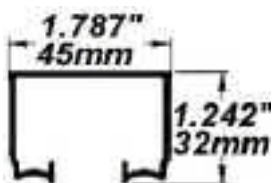

100 Track



1015BS-A



1030AOSB

1015BS-A	Basic Set
1030AOSB	Add on Set B
1019PIVS	Pivot Set
100 Track	per lineal ft

B&B Wood Products inc.

26301 Richmond Road, Bedford Hts, OH 44146-1488

(216) 292-6555 / Fax (216) 292-6584; E-mail: info@bbwood.com

Distributed by:



Price subject to change without notice.