

Bifold Hardware

1825 SERIES: 1-1/8" to 1-3/4" doors to 35 lbs. each (7/16" pivot hole). Finish Height = Door Ht+1-3/4"

2-Door Sets Finish opg size 2xDr width + 9/16"

4-Door Sets Finish opg size 4xDr width + 11/16"

Item #		List Ea.
1825-24	For openings to 24"	\$18
1825-30	For openings to 30"	\$19
1825-32	For openings to 32"	\$20
1825-36	For openings to 36"	\$20

Item #		List Ea.
1825-48	For openings to 48"	\$33
1825-60	For openings to 60"	\$35
1825-72	For openings to 72"	\$37
1825-96	For openings to 96"	\$43

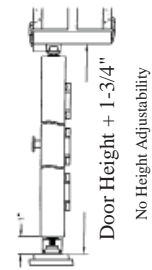

BF-50 SERIES - 1" to 1-3/4"

Item	For doors weighing up to 50 lbs	List
BF5024	For openings to 24"	\$29
BF5030	For openings to 30"	\$31
BF5036	For openings to 36"	\$33
BF5048	For openings to 48" - 4-DR	\$51
BF5060	For openings to 60" - 4-DR	\$55
BF5072	For openings to 72" - 4-DR	\$60

BF-125 SERIES-1" to 1-3/4"

Item	For doors weighing up to 125 lbs	List
BF12524	For openings to 24"	\$47
BF12530	For openings to 30"	\$49
BF12536	For openings to 36"	\$51
BF12548	For openings to 48" - 4-DR	\$88
BF12560	For openings to 60" - 4-DR	\$92
BF12572	For openings to 72" - 4-DR	\$95

Heavy Duty Hardware

Series BF-50

Up to 50 lbs. each door max. 2-doors to a jamb .
Up to 30 lbs. each door for 2+ drs to a jamb.
Door height 2-3/8" less than finished opg. height









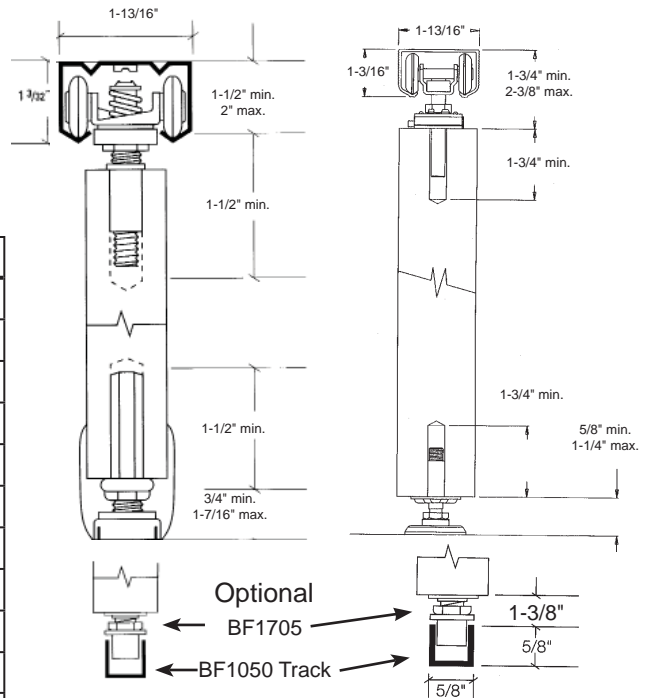

Series BF-125

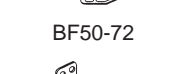
Up to 125 lbs. each door max. 2-doors to a jamb .
Up to 75 lbs. each door for 2+ drs to a jamb.
Door height min. 2-7/8" less than finished opg. height

Meets ANSI A156.14 type D8621, D8642, D8652, D8661

Meets ANSI A156.14 type D8621, D8641, D8651, D8661

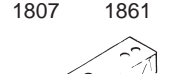

BF-50 & BF-125 Series Parts		List
 BF50-41	Three Wheel Hanger	\$10
 BF50-HDW	Pivot Set	\$7
 BF50-01	Aluminum Track (4' to 8')	pg 44
 BF50-11	Top Pivot Bracket	\$2
 BF50-22	2-Door Snugger	\$2
 BF50-24	4-Door Snugger	\$2
 BF50-36	Birch Knob 1-3/4" diam.	\$1
 BF50-60	Plastic Knob 1-3/4" diam.	\$1
 BF50-81	Jamb Bracket	\$2
 BF125N-51	Hanger & Pivot	\$37
 BP250N-01	Aluminum Track (4' to 16')	pg 44
 BF1705	Guide Roller	\$2
BF1050	Bottom Guide Channel-8'	\$14
1825 Series Parts		List
1801	Top Pivot Guide	\$1.90
1805	pr Hinges (price per pair)	\$1.60
1807	Bottom Pivot	\$1.70
1808	pr 4-Dr Aligner aka BF50-72	\$2
1836	Carpet Riser	\$1.50
1861	Jamb Bracket	\$1.10

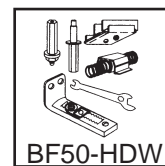

BF50-HDW

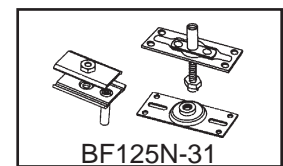

BF125N-31



BF50-41



transitioning to 3-wheel
BF125N-41

More parts shown on store.bbwood.com